



  
**DHANAM**

  
CARDIAC INSTRUMENTS



**+91 99401 10238**





01

**GENERAL INSTRUMENTS**

Forceps	1.1
BP Handles	1.16
Scissors	1.18
Needle Holders	1.22
Sternal Needle / Wire Twister	1.25
Wire Holder	1.26
Dissecting Forceps	1.27
Tube Holding Instruments	1.32
Wire Cutters	1.35
Dilators	1.36
Hollow Wares	1.38

02

**RETRACTORS**

Rib / Sternal Spreaders	2.1
Self Retaining Retractors	2.14
Cooly Mitral Valve Retractors	2.17
Kocher - Langenbeck Retractor	2.19
Aortic Valve Retractors	2.21
VSD Retractors	2.22
Harrington Retractors	2.23
Davers Retractors	2.24
Davidson Retractors	2.25
Allison Lung Retractors	2.26

# TABLE OF CONTENTS

Mories Retractors	2.27
Rack Retractors	2.28
Zereny Retractor	2.30
Epicardial Fat Retractors	2.31
Malleable Retractors	2.32
Hooks	2.33

03

## SUCTION INSTRUMENTS

Cardiotomy Suction Tubes	3.1
Rough Suction Tubes	3.2
Suction Tips	3.3
Suction Tips & Cannulas	3.4

04

## BONE INSTRUMENTS

Bone Cutters	4.1
Elevators	4.3
Rongeurs	4.6

05

## MICRO INSTRUMENTS

Needle Holders	5.1
Scissors	5.7
Ring Tip Forceps - SS	5.15
Debakey Forceps - SS	5.17
Platform Forceps - SS	5.18



Delicate Forceps	5.19
Ring Tip Forceps - Ti	5.20
Debakey Forceps - Ti	5.22
Platform Forceps - Ti	5.25
Debakey Forceps	5.26
Resano Forceps	5.29
Bulldog Clamps	5.30
Coronary Probes	5.31
Dessectors	5.32

## 06

### DEBAKEY VASCULAR CLAMPS

Ring Handle Bulldog Clamps	6.1
Neonatal Castaneda clamps	6.3
Deep Curved Multi Purpose Clamps	6.5
Angled Multi Purpose Clamps	6.6
Derra Cooley Clamps	6.7
Ligature Clamps	6.10
Beck Clamps	6.11
Herken Clamps	6.12
Tangential Occlusion Clamps	6.13
Satinsky Clamps	6.14
Cross Clamps	6.16
SEMB Arota Aneurysm Clamps	6.22
Arota Aneurysm Clamps	6.23
Arota Clamps	6.24
Lambert-Key Clamps	6.25

**TITANIUM MICRO CLAMPS**

Debakey Straight Clamp	6.26
Debakey Side Biting Angled Clamps	6.27
Debakey Angled Clamps	6.28

**07**

**MICS INSTRUMENTS**

MICS Intercostal Retractor Set	7.1
MICS IMA Retractor Arc + Coupler Set	7.2
MICS LA Attachment	7.3



## Forceps

GM 1110

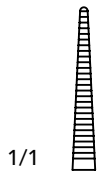

1/1

4" (100 mm)

GM 1210



1/1

4" (100 mm)

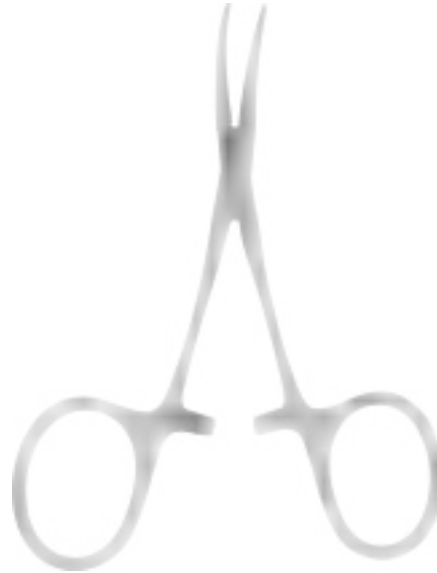

Baby Mosquito Forceps

GM 1112

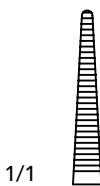

1/1

5" (125 mm)

GM 1212



1/1

5" (125 mm)

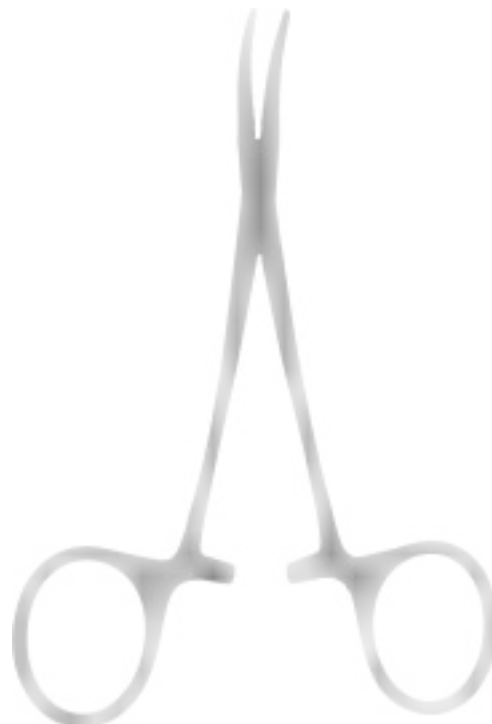

Mosquito Forceps

## Forceps

GA 1115

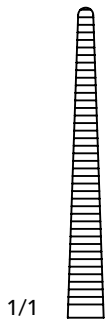

6" (150 mm)

GA 1215

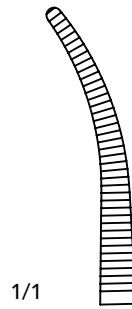

6" (150 mm)



Artery Forceps

## Forceps

GA 1120

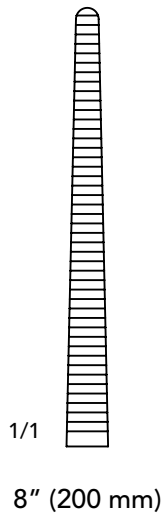

GA 1220

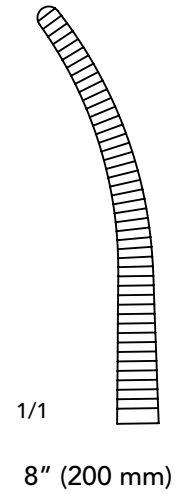

GA 1223

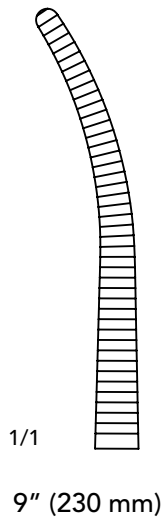

GA 1225

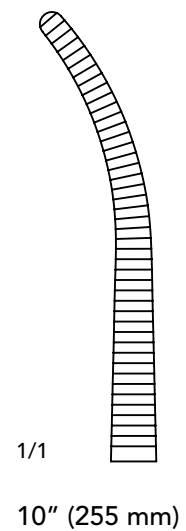

Artery Forceps

## Forceps

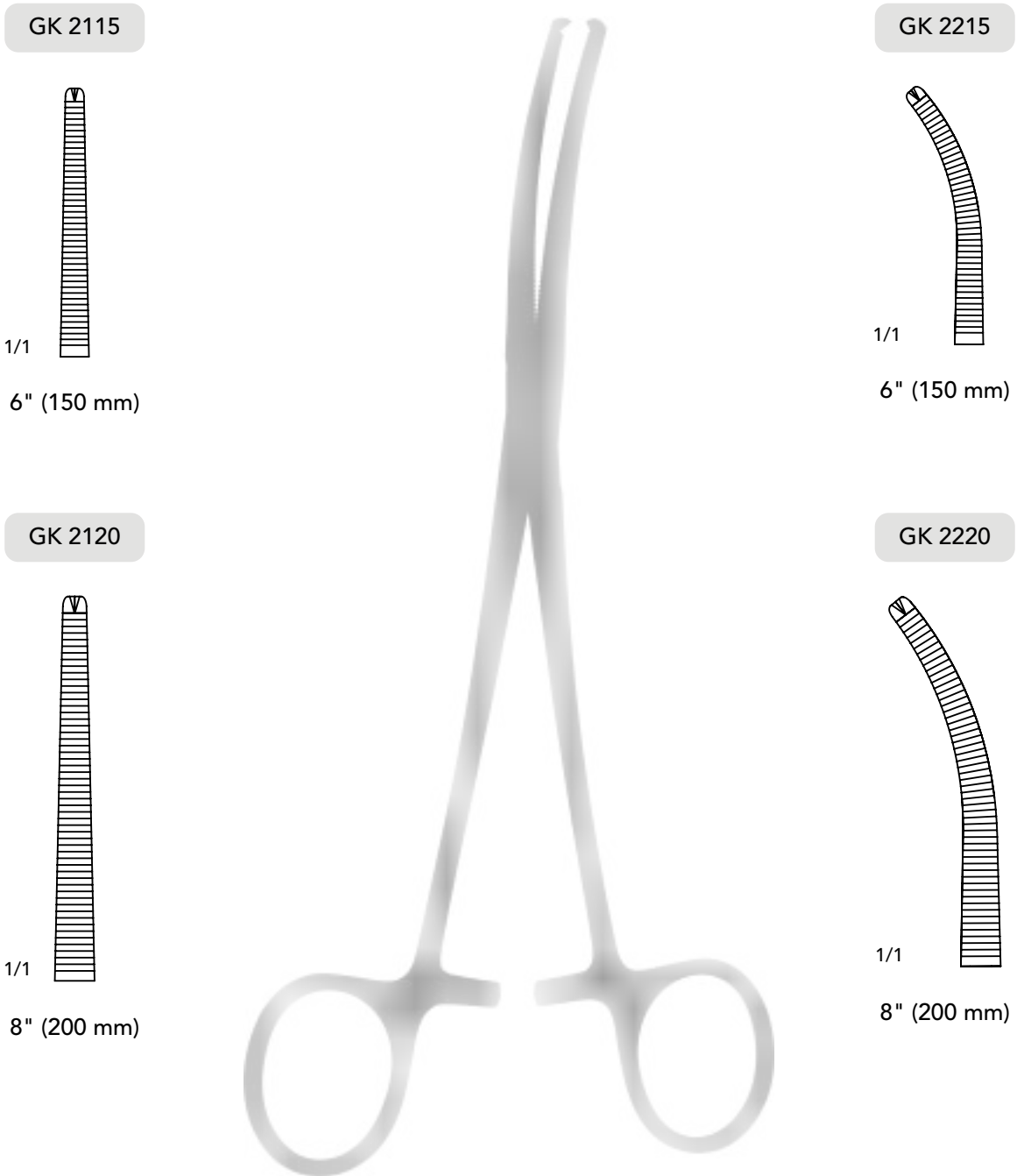

Kocher Forceps

## Forceps

GL 3015

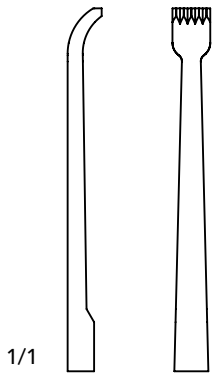

6" (150 mm)

GL 3020

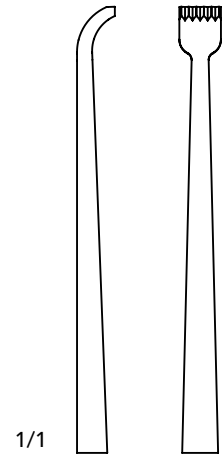

8" (200 mm)



Allis Forceps



## Forceps

GB 4015

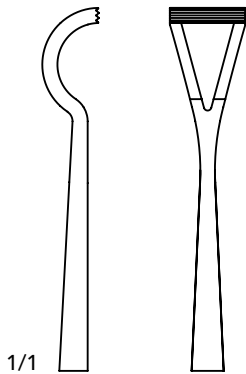

6" (150 mm)

GB 4020

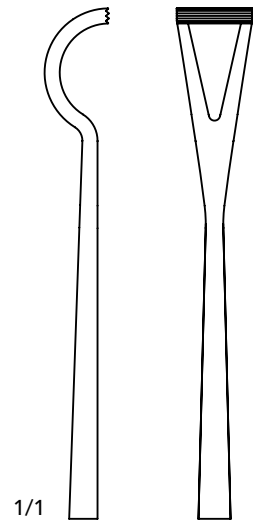

8" (200 mm)



Babcock Forceps

GT 5010

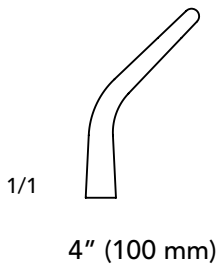

GT 5012

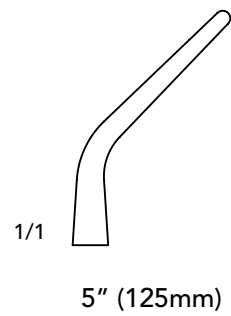

Towel Clip Forceps (Backhaus)

## Forceps

GE 1215

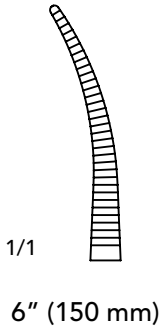

GE 1218

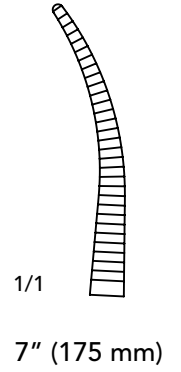

GE 1220

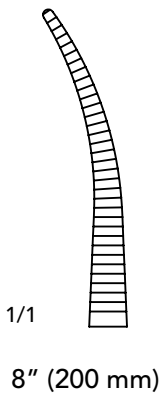

GE 1223

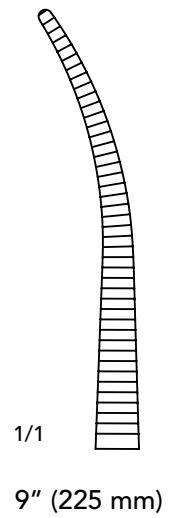

GE 1225

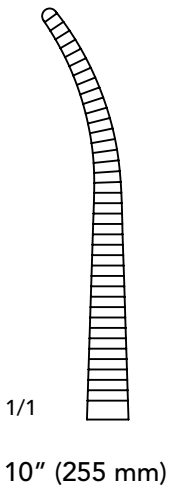

Kellies Artery Forceps

## Forceps

GE 1315

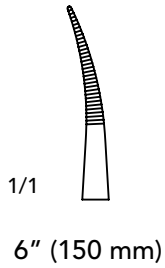

GE 1327

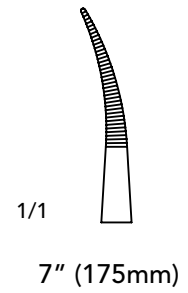

GE 1320

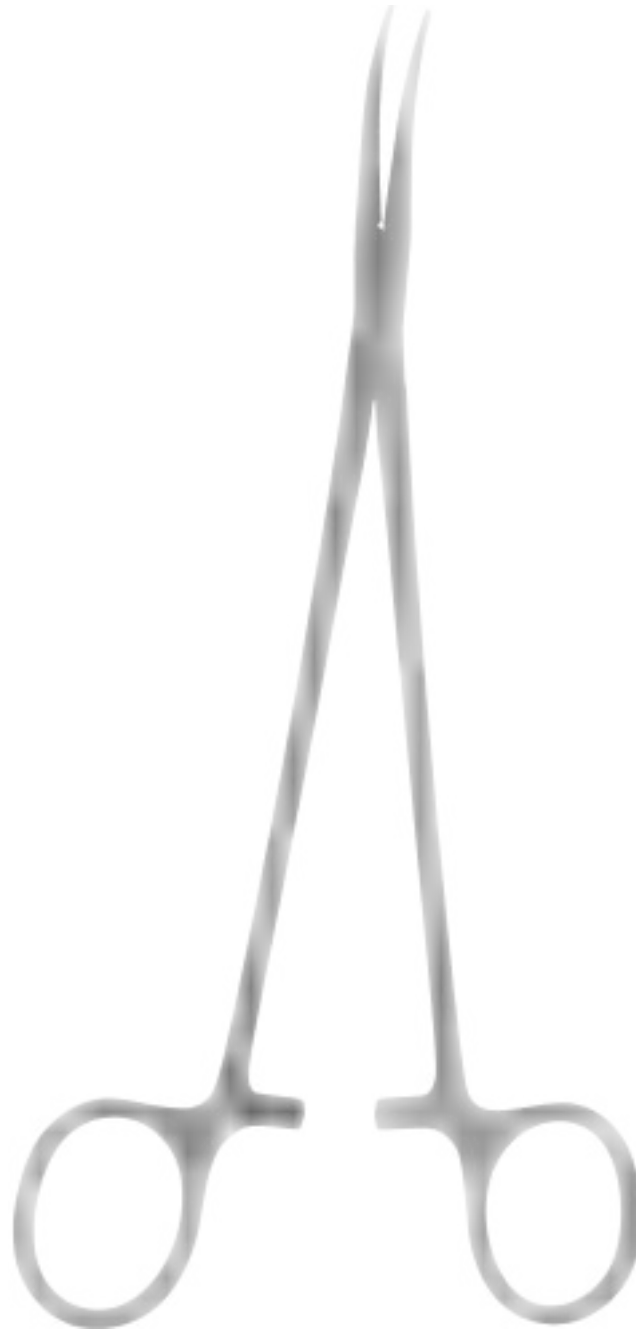
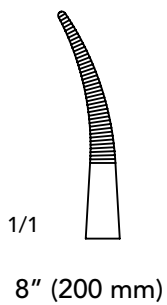

Kellies Artery Forceps Fine "Paediatric"

## Forceps

GR 7018

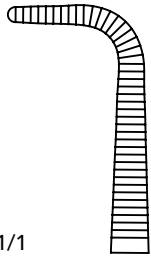

1/1

7" (175 mm)

GR 7023

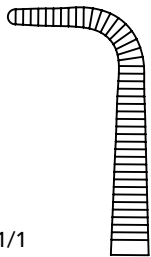

1/1

9" (225 mm)

GR 7020

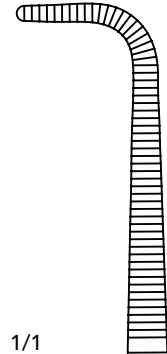

1/1

8" (200 mm)

GR 7025

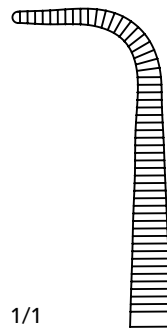

1/1

10" (255 mm)



Right Angle Forceps STD

GR 1113

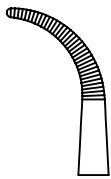

5 1/2" (140 mm)

1/1

GR 1313

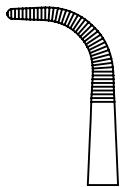

5 1/2" (140 mm)

1/1

GR 1217

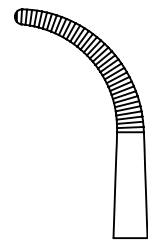

7" (175 mm)

1/1

GR 1417

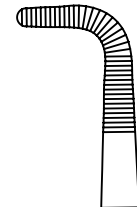

7" (175 mm)

1/1



Right Angle Forceps Fine "Paediatric"

## Forceps

GO 8215

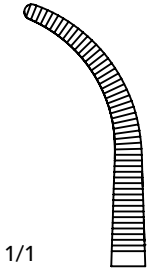

1/1

6" (150 mm)

GO 8218

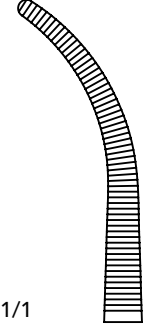

1/1

7" (175 mm)

GO 8220

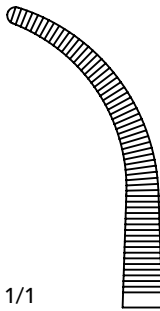

1/1

8" (200 mm)

GO 8223

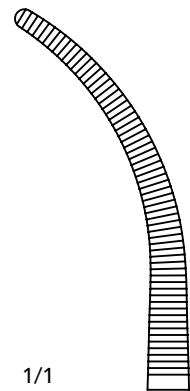

1/1

9" (225 mm)

GO 8225

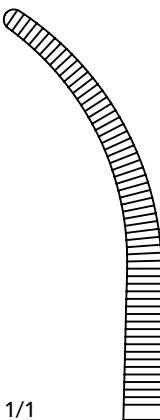

1/1

10" (225 mm)



Robert Artery Forceps

GS 9118

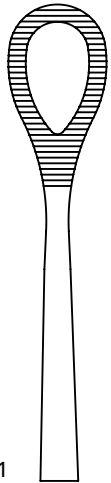

1/1

8" (200 mm)

GS 9125

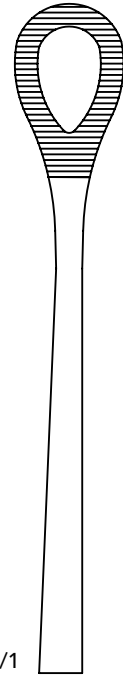

1/1

10" (225 mm)



Sponge Holding Forceps



GD 0123

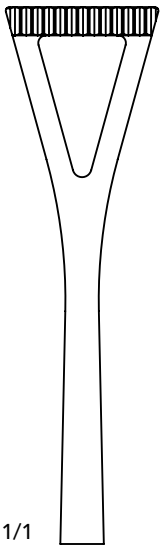

1/1

9" (230 mm)



Duval Lung Forceps

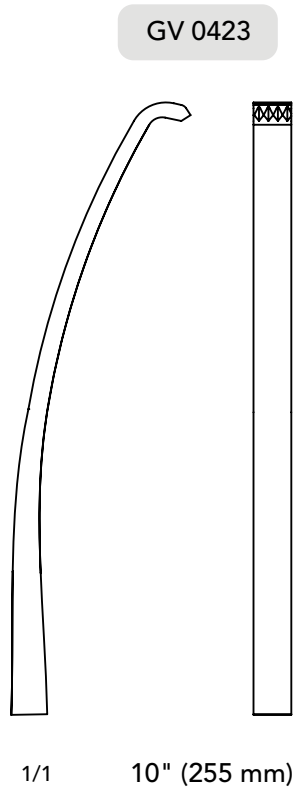

Vulsellum Forceps

## BP Handles

BP 0323



1/1

Size 3, 5"

BP 0413



1/1

Size 4, 5 1/2"

BP 0313



1/1

Size 3L, 8 1/2"

### BP Handles

## BP Handles

BP 0715



1/1

Size 7, 6 3/4"

BP 0723



1/1

Size 7L, 9"

### BP Handles

## Scissors

SZ 1115

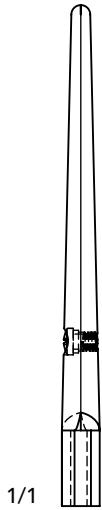

1/1

6" (150 mm)

SZ 1215

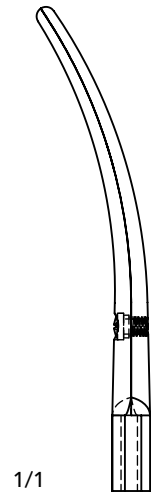

1/1

6" (150 mm)

SZ 1117

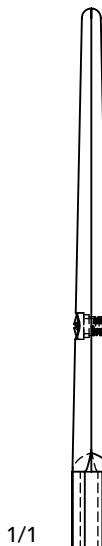

1/1

7" (175 mm)

SZ 1217

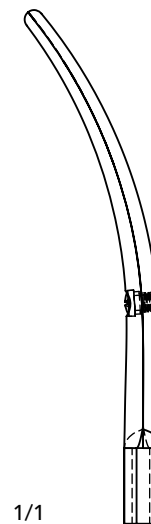

1/1

7" (175 mm)



Metzenbaum Scissors

## Scissors

SZ 1120

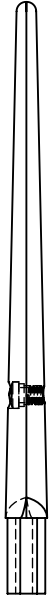

1/1

8" (195 mm)

SZ 1220

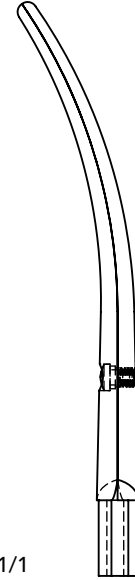

1/1

8" (195 mm)

SZ 1123



1/1

9" (225 mm)

SZ 1223

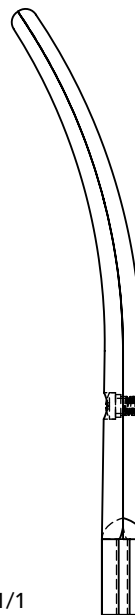

1/1

9" (225 mm)



Metzenbaum Scissors



SZ 1228

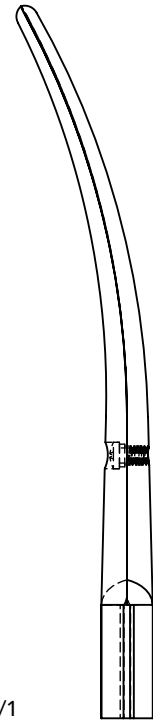

1/1

11" (270mm)

Nelson Metzenbaum Scissor

SY 2117

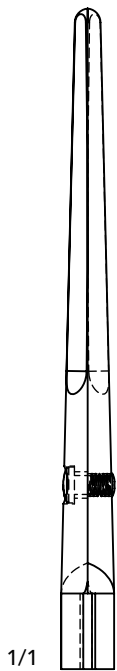

1/1

7" (175 mm)

SY 2217

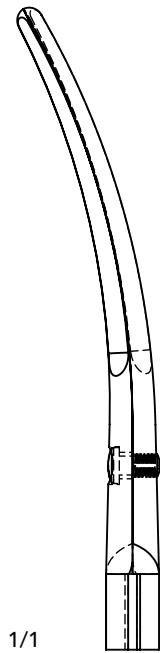

1/1

7" (175 mm)



Mayo Scissors



## Needle Holders

NM 2015

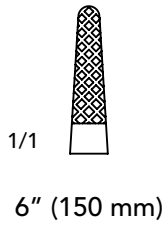

NM 2018

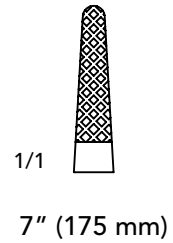

NM 2020

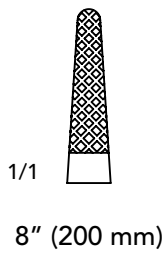

NM 2023

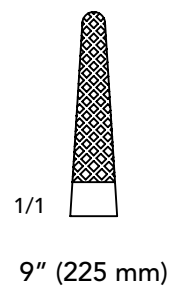

NM 2025

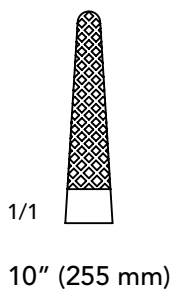

Mayo Hegar Needle Holders with TC Tip (1/O, 2/O & 3/O)

## Needle Holders

ND 3015

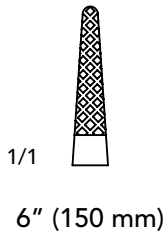

ND 3018

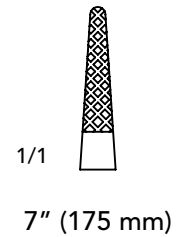

ND 3020

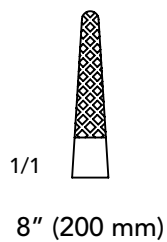

ND 3023

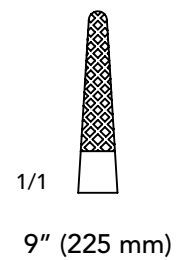

ND 3025

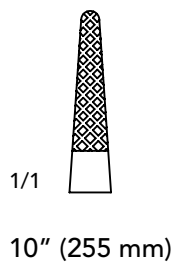

ND 3026

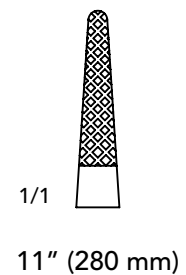

Debakey Needle Holders with TC tip (4/O & 5/O)

## Needle Holders

NR 5018

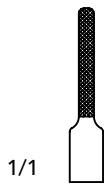

7" (175 mm)

NR 5020



8" (200 mm)

NR 5023

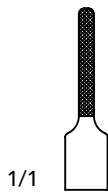

9" (225 mm)



Ryder Needle Holders with TC tip (5/O & 6/O)

NW 7015

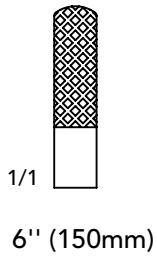

NW 7020

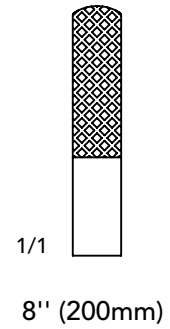

Sternal Needle / Wire Twister with TC Tip



WH 8015



1/1

6" (150 mm)

\* Wire Holder WITHOUT TC Tip

**\* - This model is without TC tip, Only usable for Holding Purpose,  
Not recommended to Heavy Usage and Wire Twisting.**

## Dissecting Forceps

FP 1115

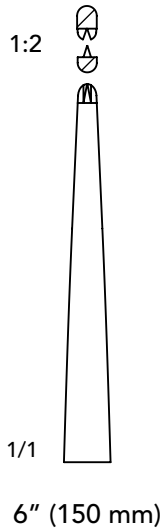

FP 1118

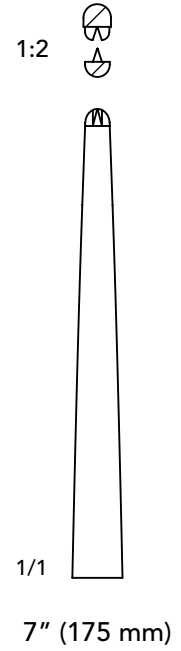

FP 1318

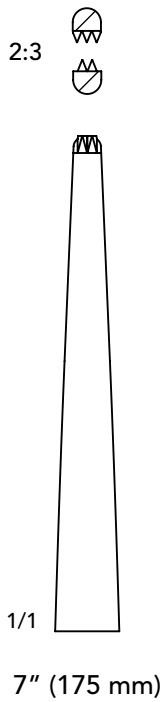

Dissecting Forceps Toothed

## Dissecting Forceps

FP 1215

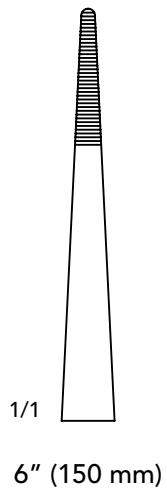

FP 1218

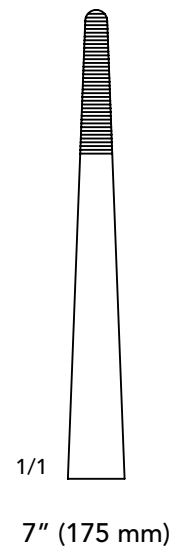

Dissecting Forceps Non-Toothed

## Dissecting Forceps

FP 1215

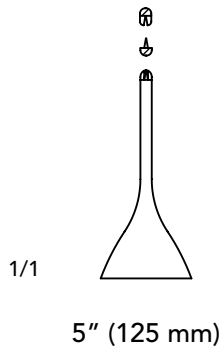

FP 1218

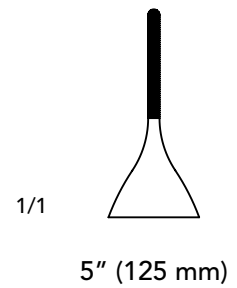

Adson Forceps Toothed & Non - Toothed



## Dissecting Forceps

FT 4020

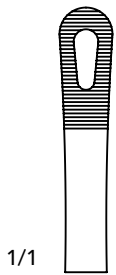

1/1

8" (200 mm)

FT 4025



1/1

10" (250 mm)



Tuttle Forceps

## Dissecting Forceps

FR 3020



1/1

8" (200 mm)

FR 3025



1/1

10" (250 mm)



Russian Forceps

## Tube Holding Instruments

LT 1015



1/1

6" (150mm)

LT 1020

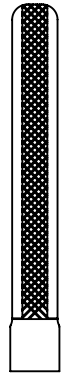

1/1

8" (200mm)



Tube Clamp

## Tube Holding Instruments

LT 1215

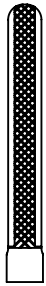

1/1

6" (150mm)

LT 1220

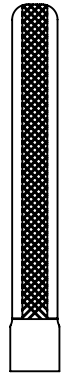

1/1

8" (200mm)



Tube Clamp With Guard

## Tube Holding Instruments

LR 5020



Tube Milker 8", 200 mm

LO 6015



Tube Organizer with Base Plate 8", 200 mm  
(Stainless Steel)

## Wire Cutters



Wire Cutter Double Action TC

## Dilators

DH 3015

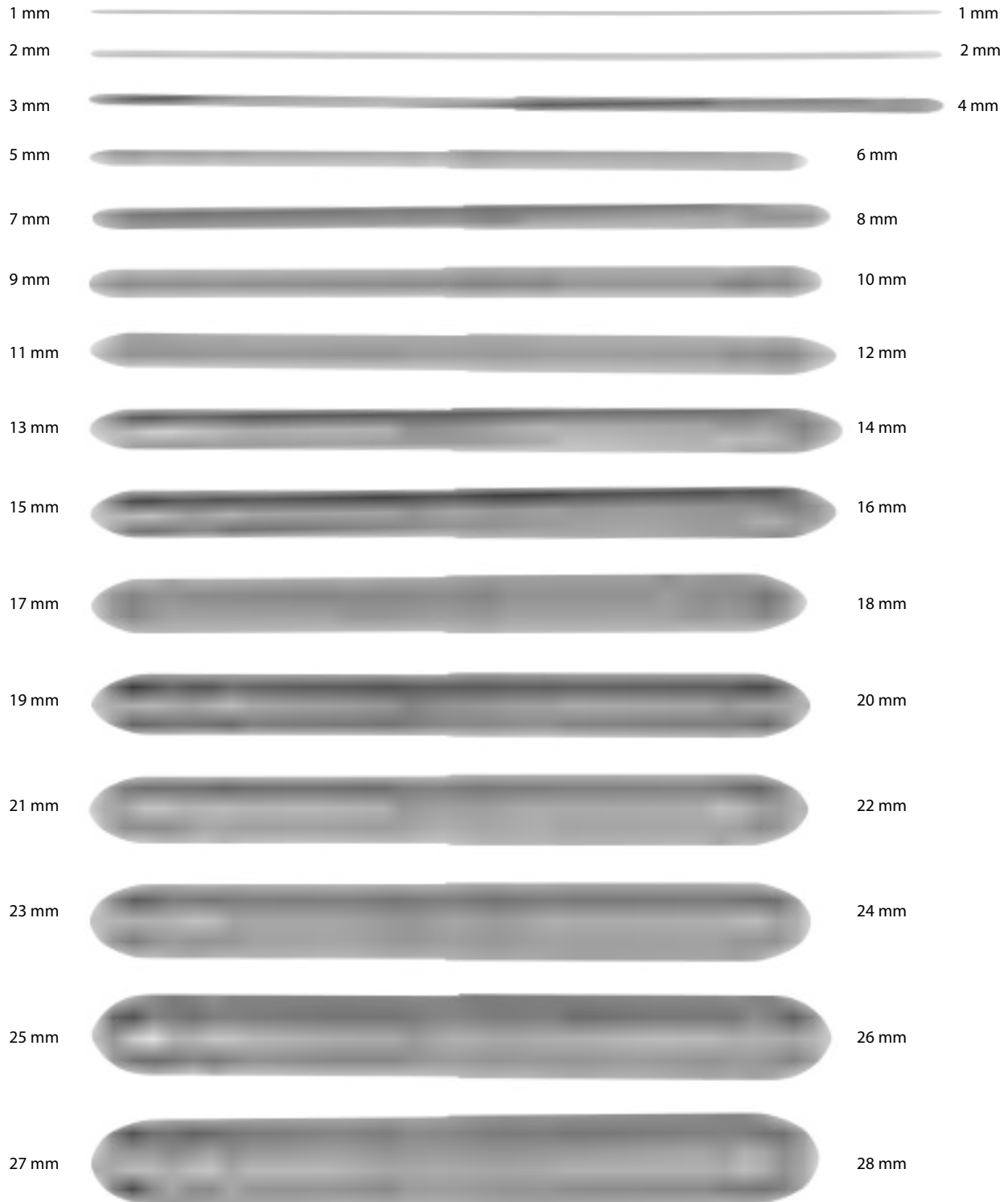

Hegar Dilators

DR 5112



Trachal Dilator 5", 125 mm



HW 1015



3/4

Scale 6", 150 mm

HW 1030



1/2

Scale 12", 300 mm

HW 2015



1/1

Spoon 6", 150 mm

HW 4010



1/1

Small 4", 100 mm

HW 4020



3/4

Big 8", 200 mm

Kidney Trays

## Hollow Wares

HW 3010



1/1

Small 3", 75 mm

HW 3020



1/1

Medium 4", 100 mm

HW 3030



1/1

Big 5", 125 mm

Bowels





## Rib / Sternal Spreaders

RF 2001T

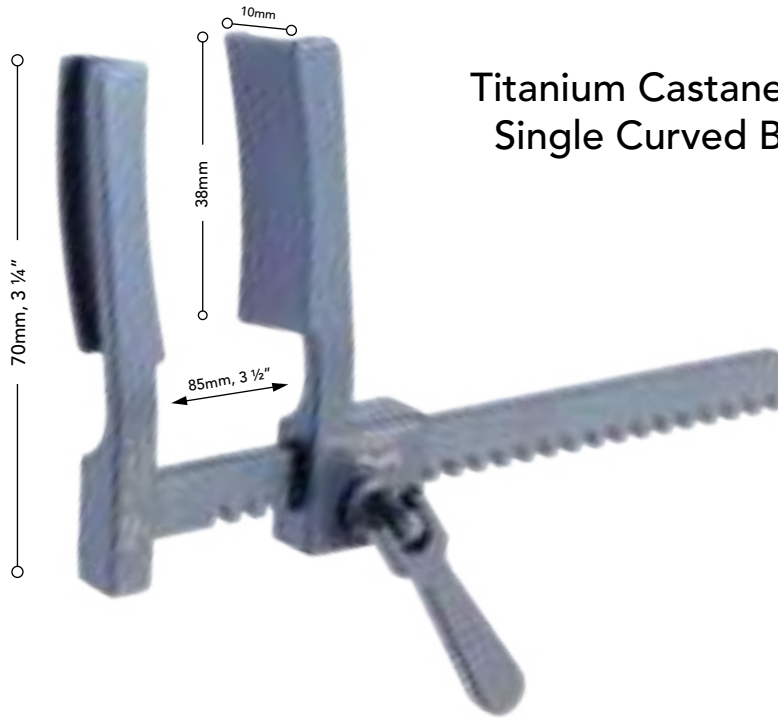

Titanium Castaneda Retractor with Single Curved Blade Extra Small

1/1

RF 2002T

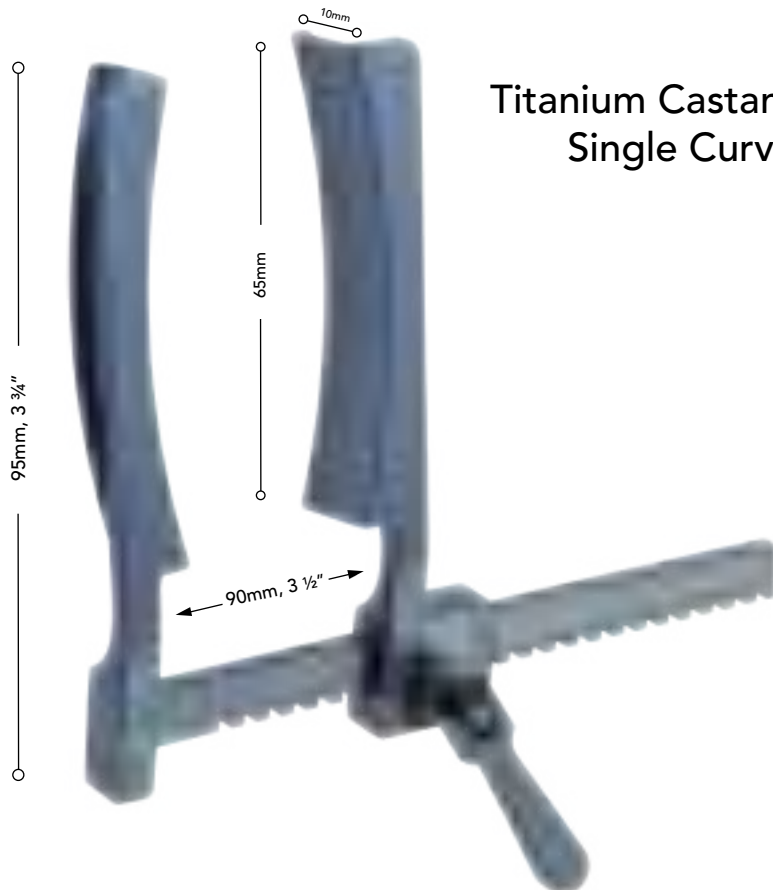

Titanium Castaneda Retractor with Single Curved Blade Small

1/1

## Rib / Sternal Spreaders

RF 2008

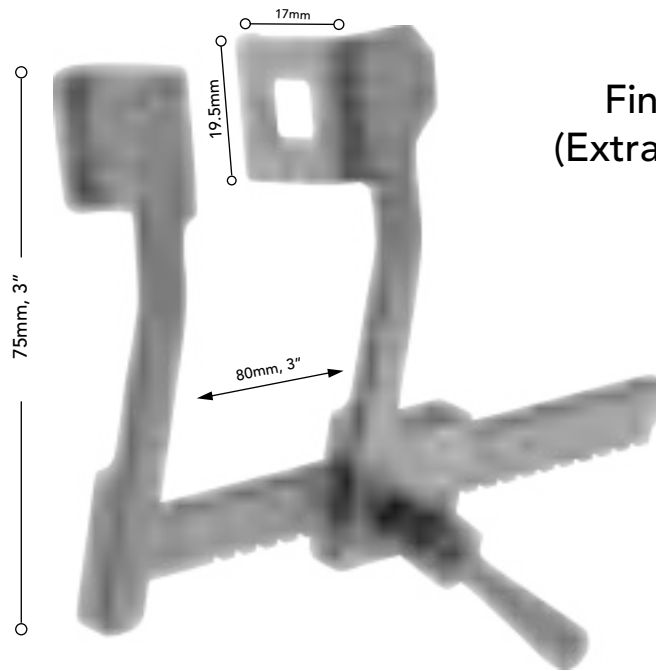

Finochietto Rib Retractor  
(Extra Small) With Single Blade

1/1

RF 2110

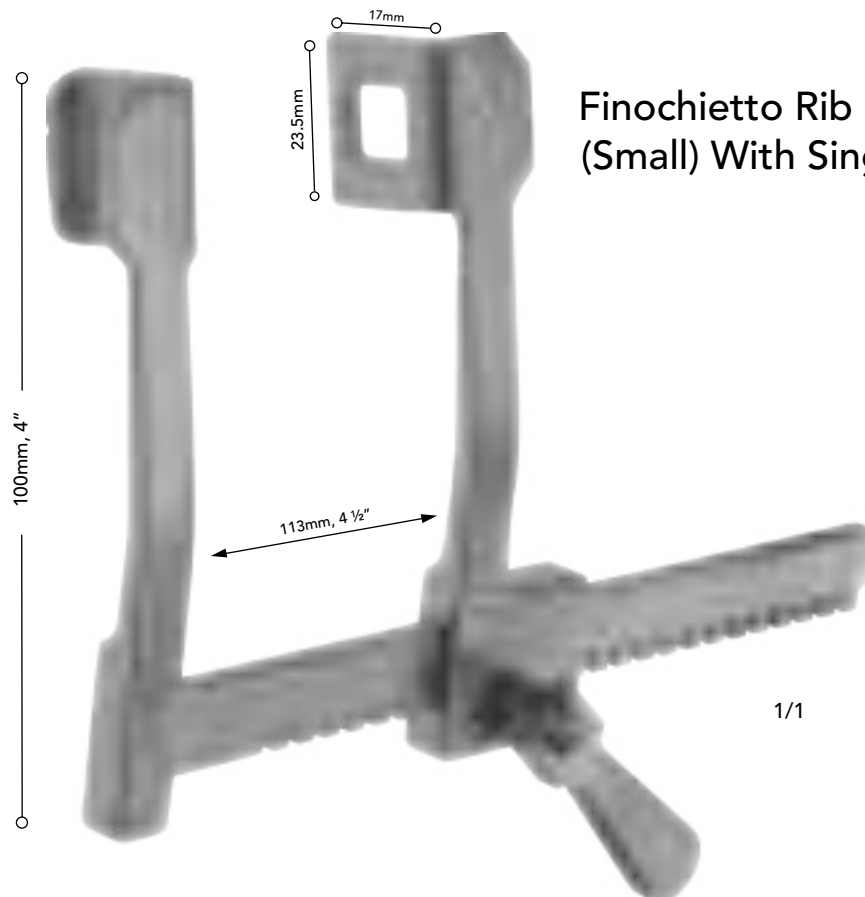

Finochietto Rib Retractor  
(Small) With Single Blade

1/1

## Rib / Sternal Spreaders

RM 4008

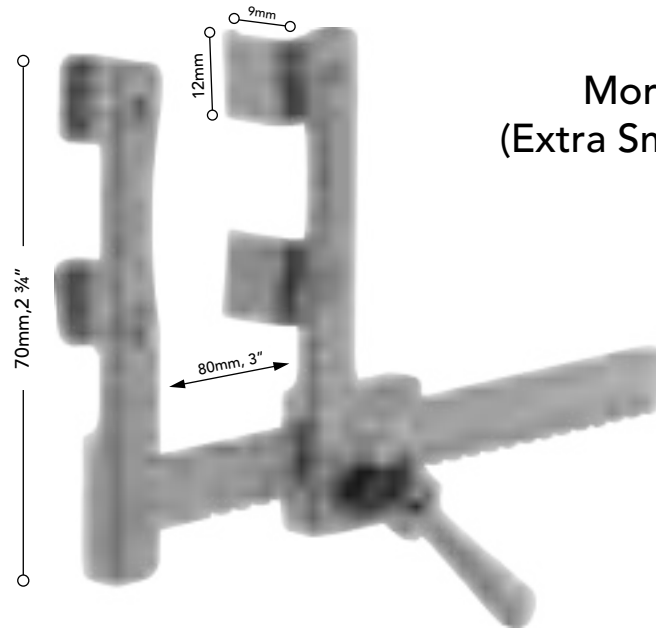

Morse Sternal Spreader  
(Extra Small) With Double Blades

1/1

RM 4110

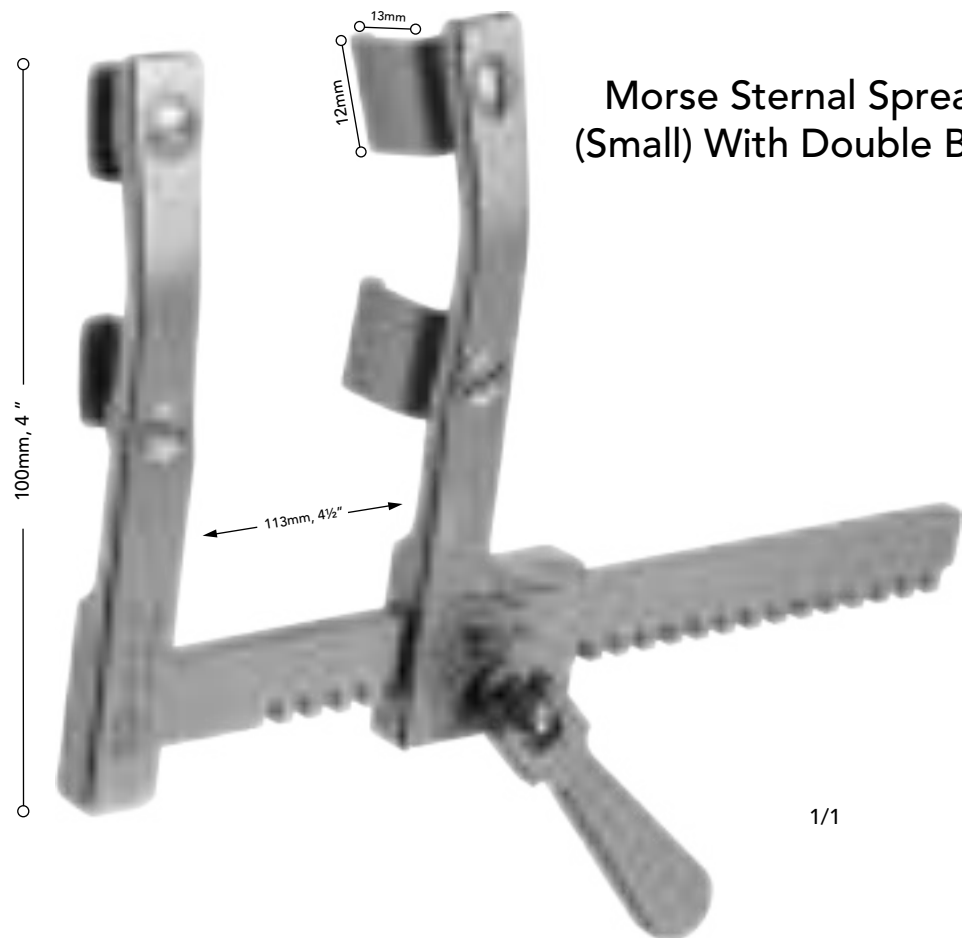

Morse Sternal Spreader  
(Small) With Double Blades

1/1



## Rib / Sternal Spreaders

RF 2215

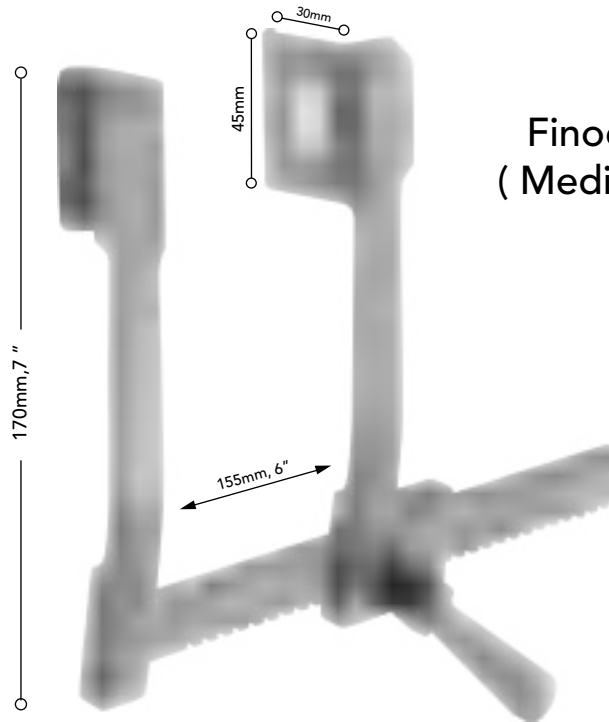

Finochietto Rib Retractor (Medium) With Single Blade

1/2

RF 2320

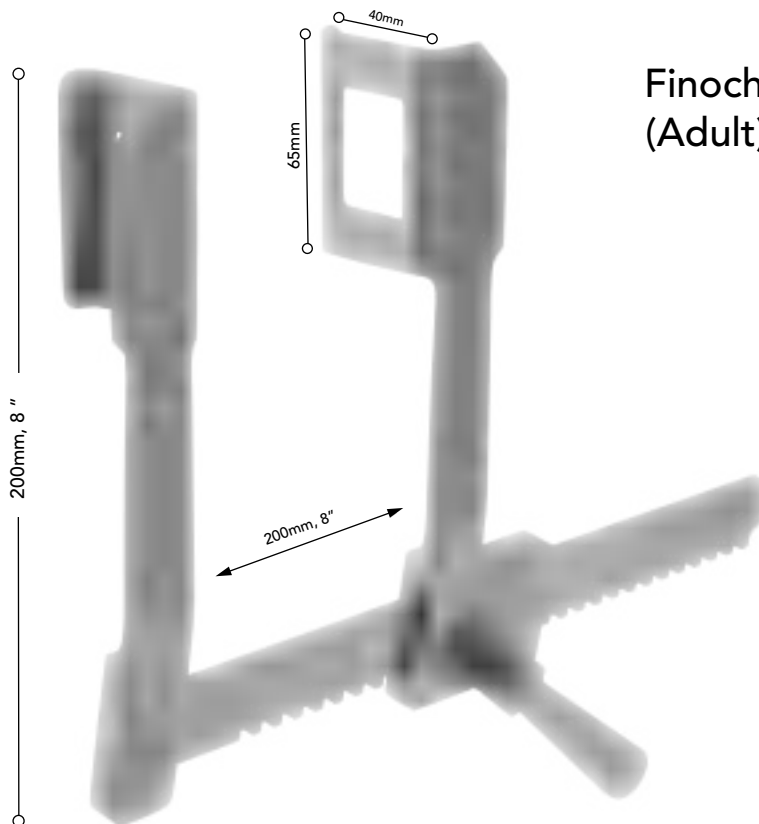

Finochietto Rib Retractor (Adult) With Single Blade

1/2

## Rib / Sternal Spreaders

RF 2425

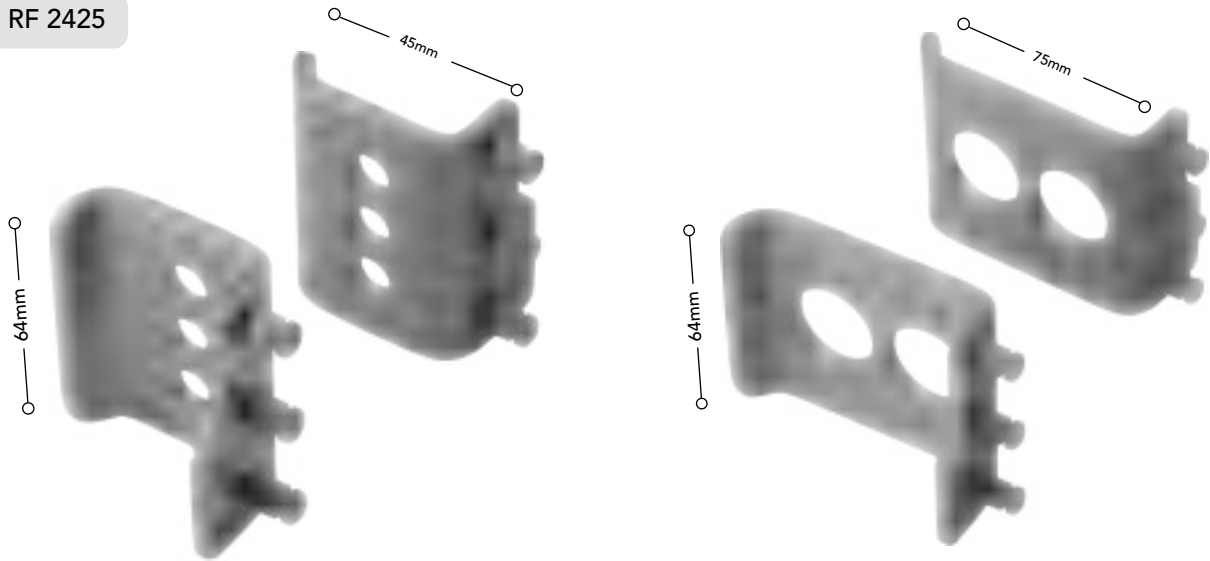

Small Blade - 45x64mm

Big Blade - 75x64mm

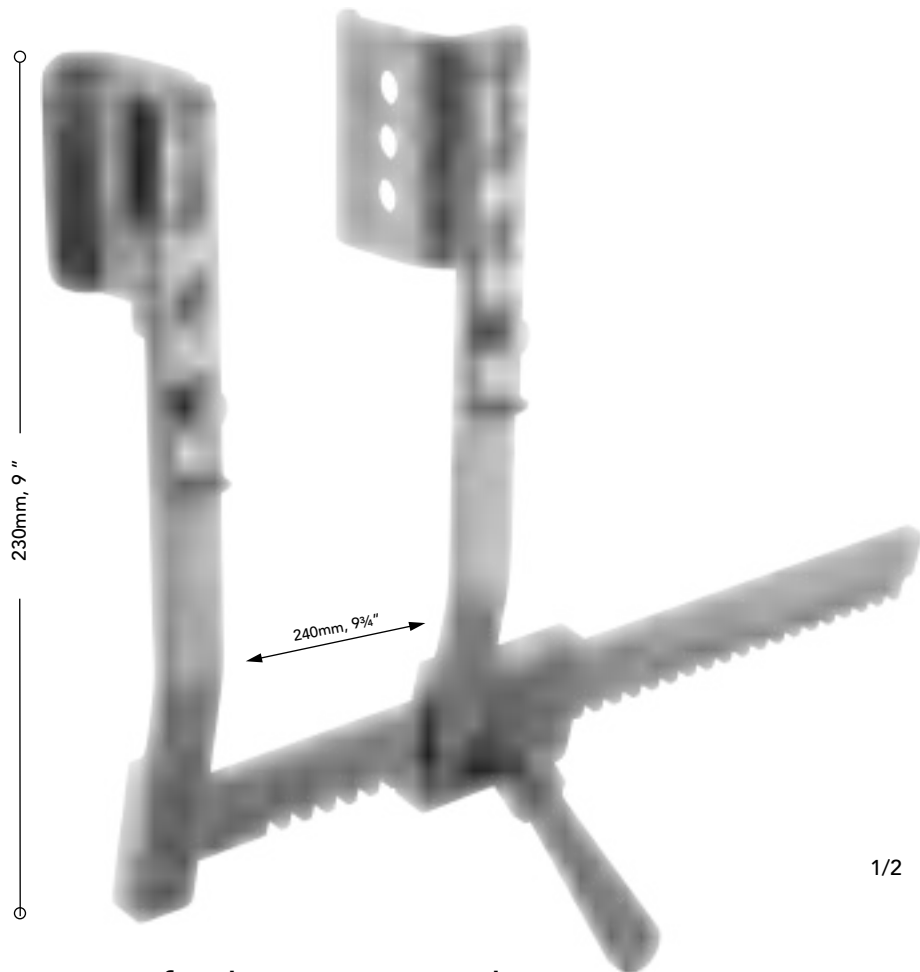

Finochietto Burford Retractor With Two Pair of Detachable Blades

## Rib / Sternal Spreaders

RM 4112

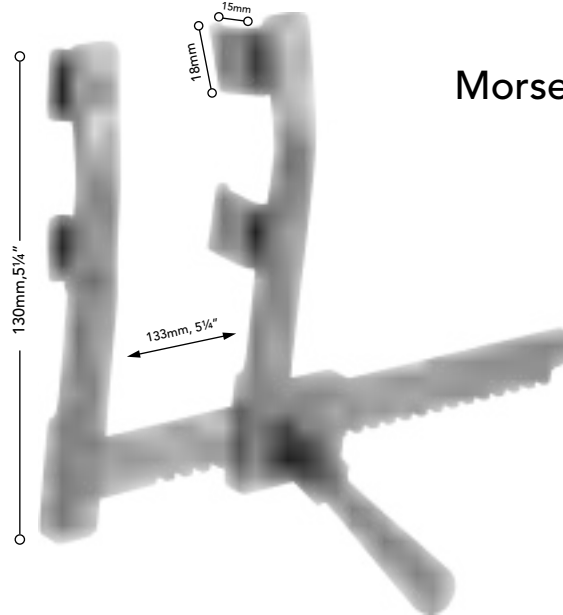

Morse Sternal Spreader Inbetween Medium & Small (IMS)

1/2

RM 4215

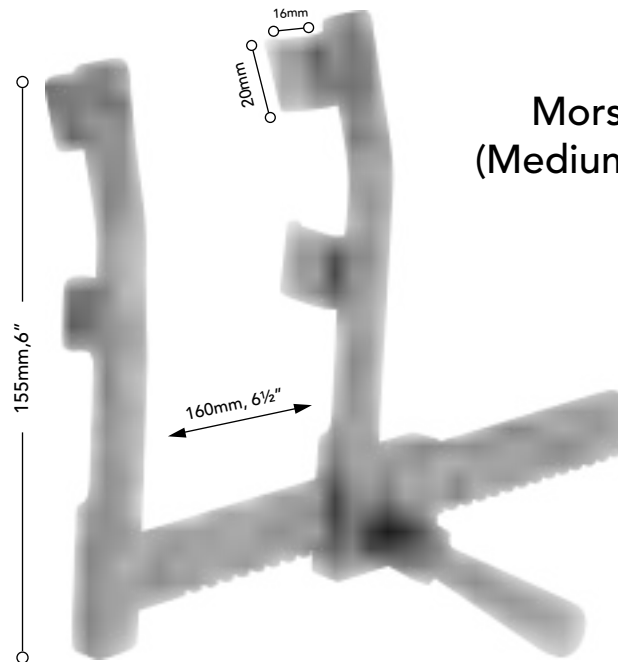

Morse Sternal Spreader (Medium) With Double Blades

1/2

## Rib / Sternal Spreaders

RM 4320

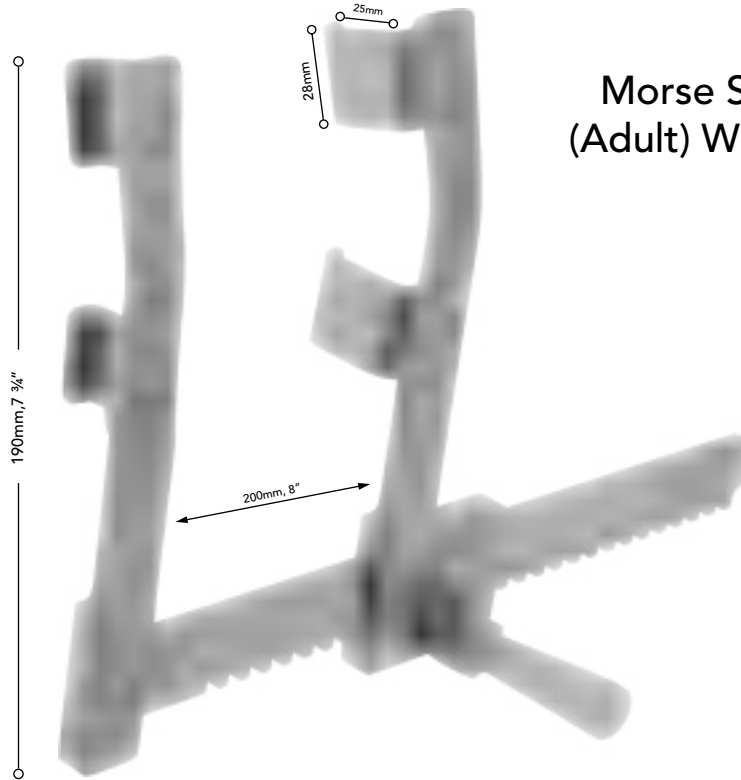

Morse Sternal Spreader (Adult) With Double Blades

1/2

RM 4420

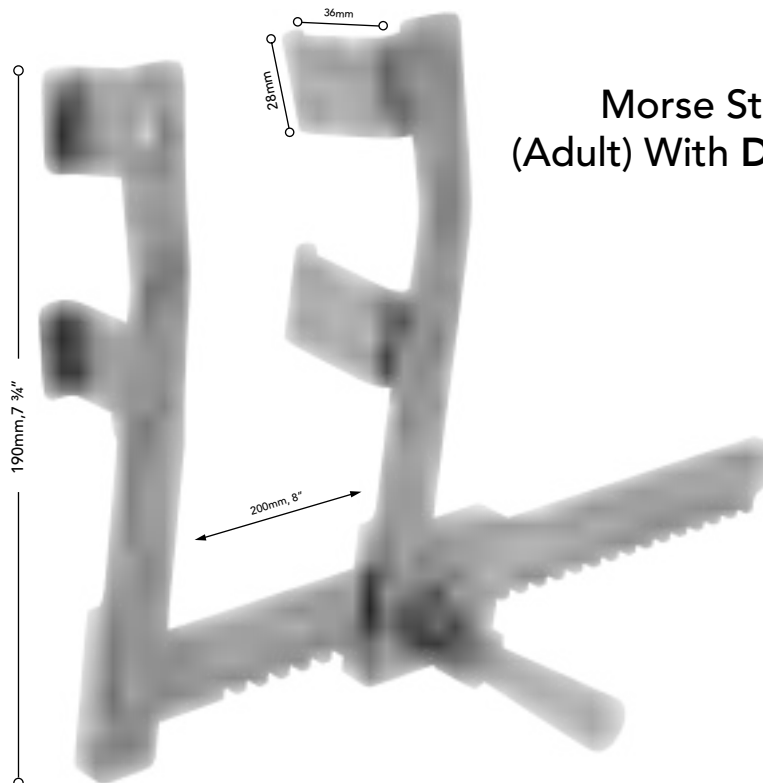

Morse Sternal Spreader (Adult) With **DEEP** Double Blades

1/2

RM 4320-NH

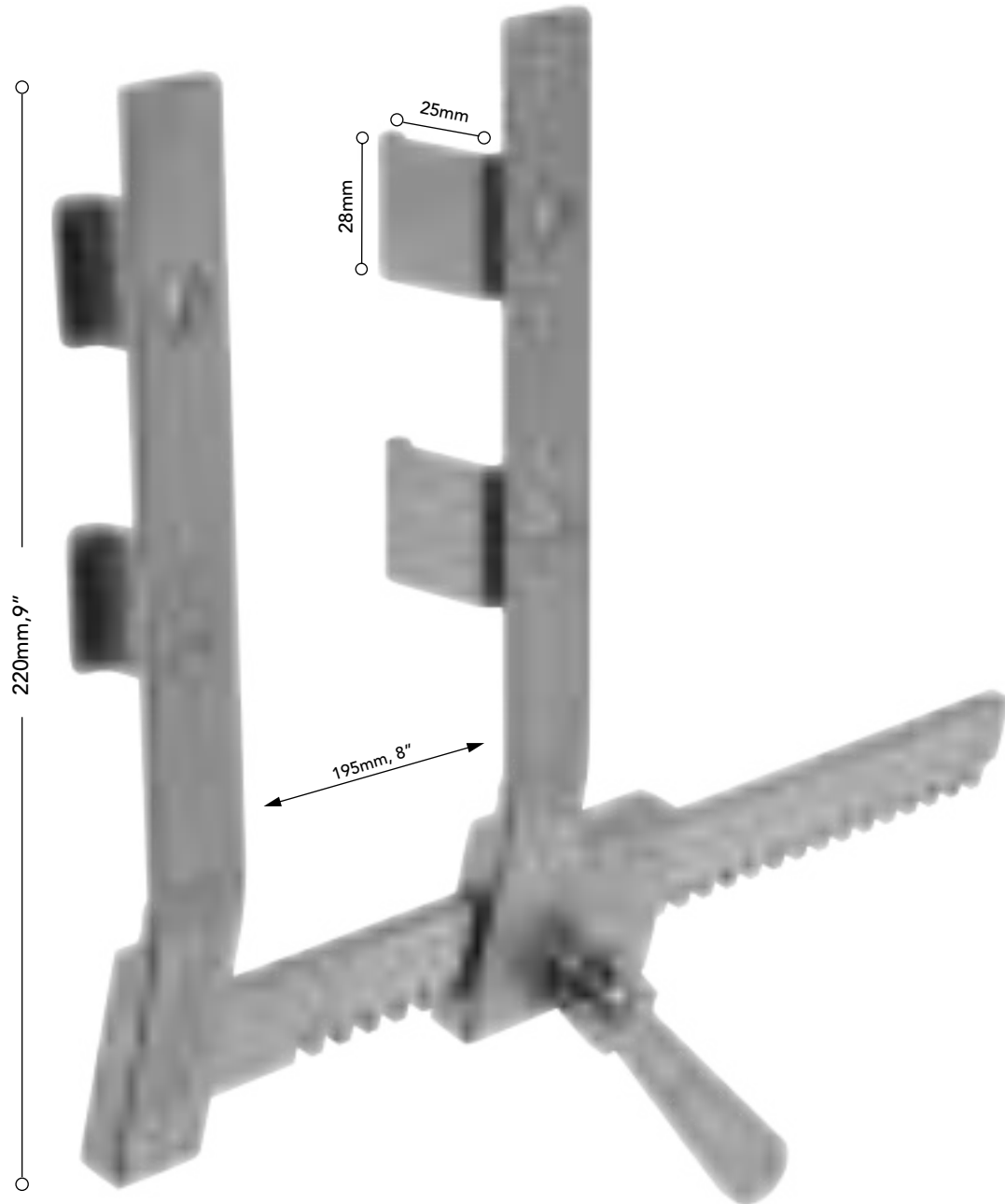

Morse Sternal Spreader (Adult)  
with tissue stabilizer compatibility

Rib / Sternal Spreaders

RI 1020

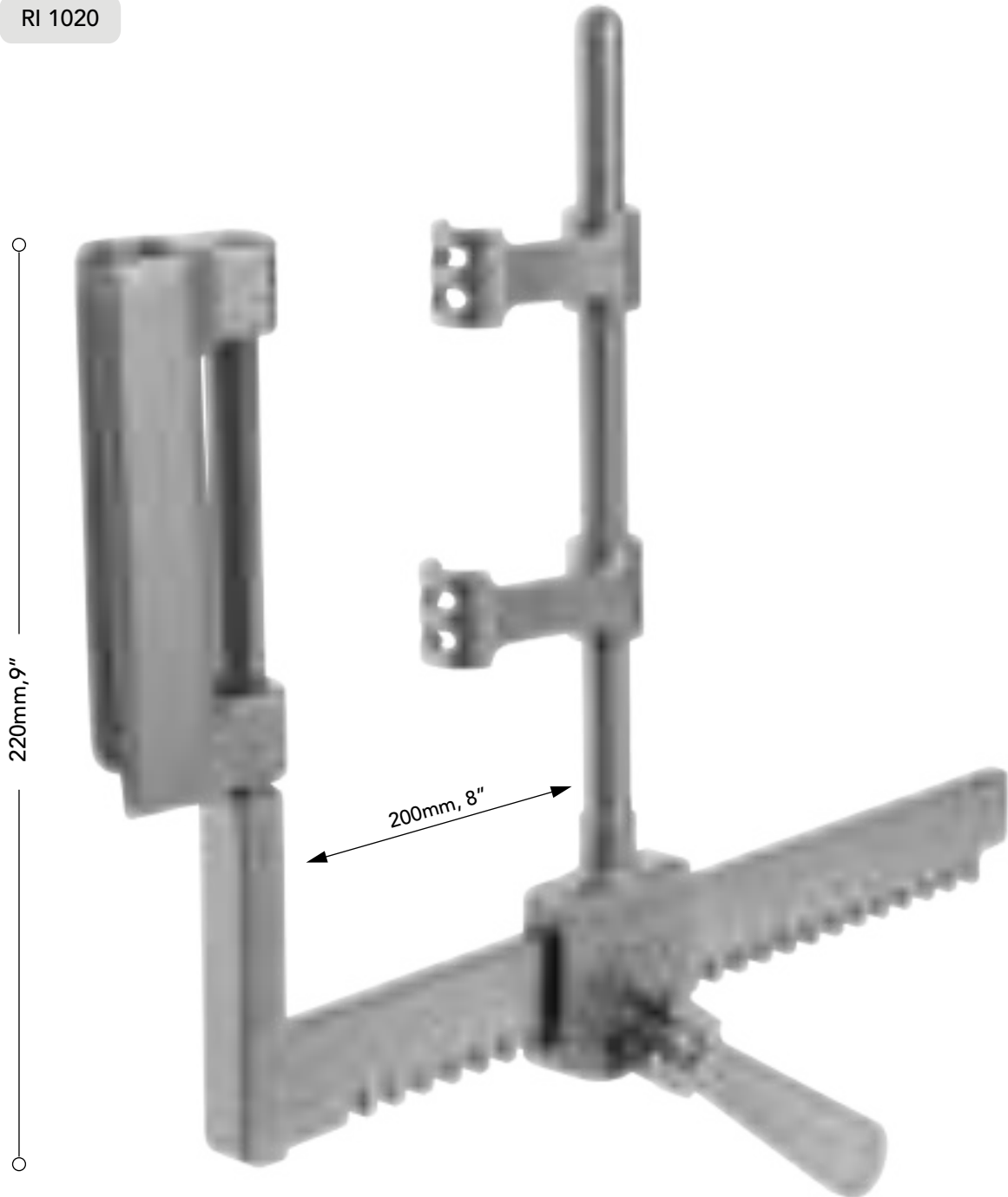

IMA Retractor

RI 0110



1/1

**IMA Retractor Blade**  
*(To convert standard double blade Retractor to IMA Retractor)*

RP 1020



Designed by  
Dr. P.V. Rao FRCS, FRCS

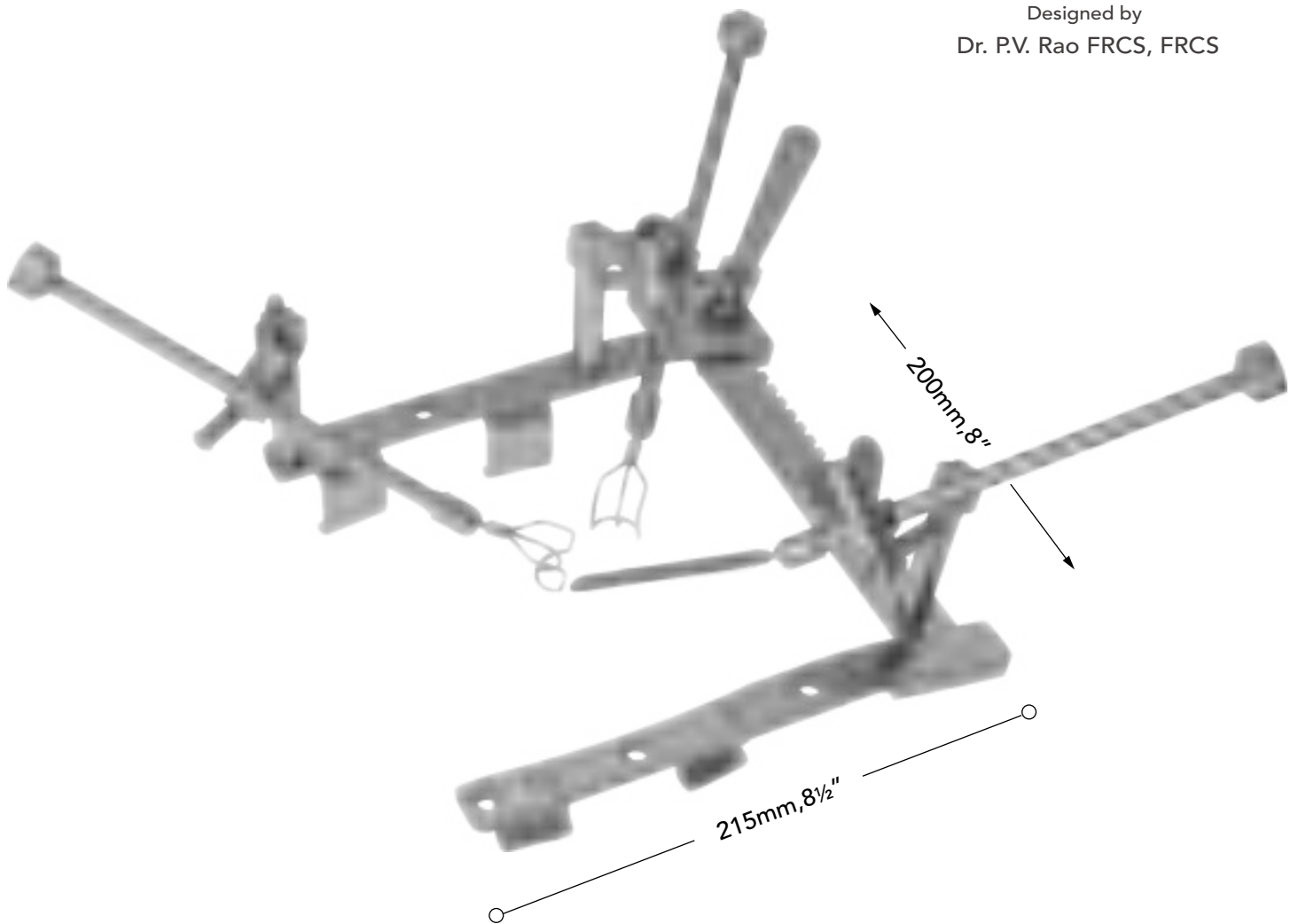

PV Rao-Dhanam Mitral Valve Exposure System



Rib / Sternal Spreaders

RC 1020

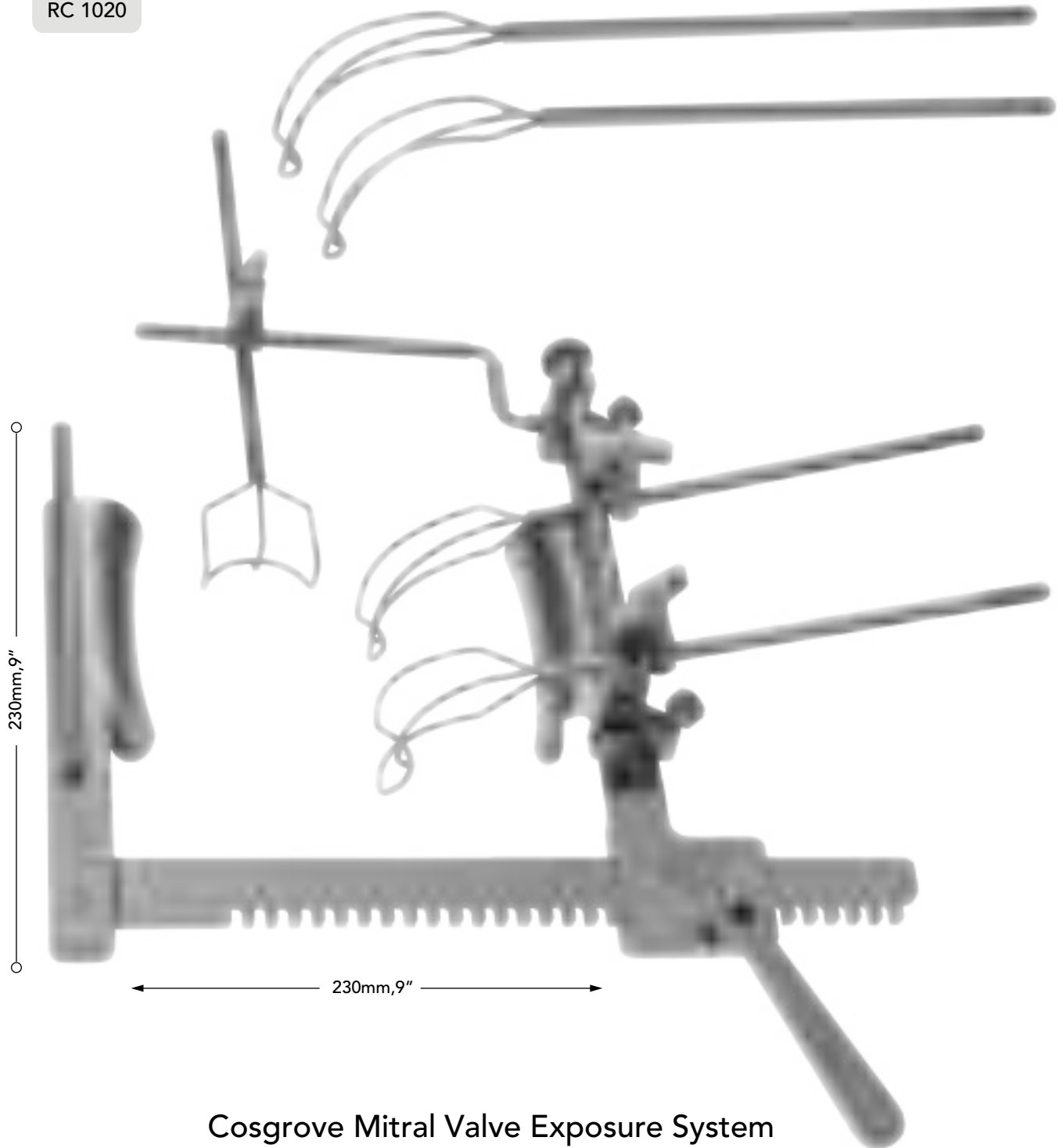

Cosgrove Mitral Valve Exposure System

## Rib / Sternal Spreaders

RB 1018



1/1

Bailey Rib Approximator (Small)

RB 1020



1/1

Bailey Rib Approximator (Big)

## Self Retaining Retractors

RH 1113

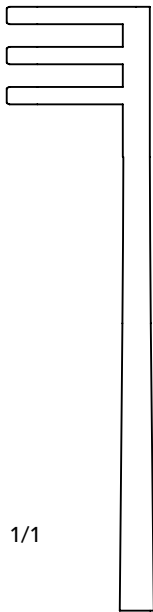

RH 2113

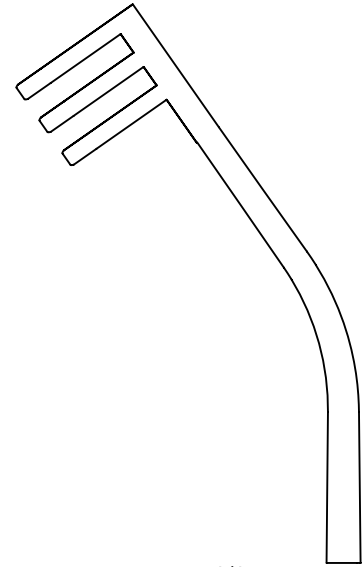

Henly Popliteal Self Retaining Retractor (Small) 5 1/2"

## Self Retaining Retractors

RH 1217

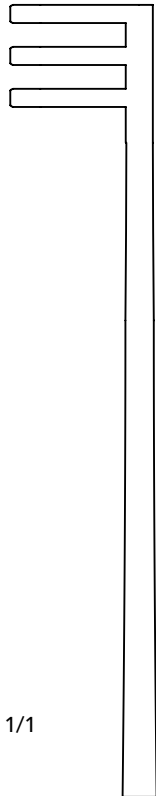

RH 2217

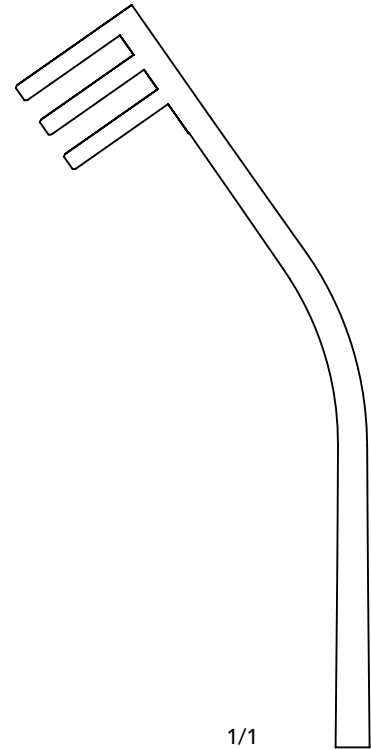

Henly Popliteal Self Retaining Retractor (Medium) 6 1/2"

## Self Retaining Retractors

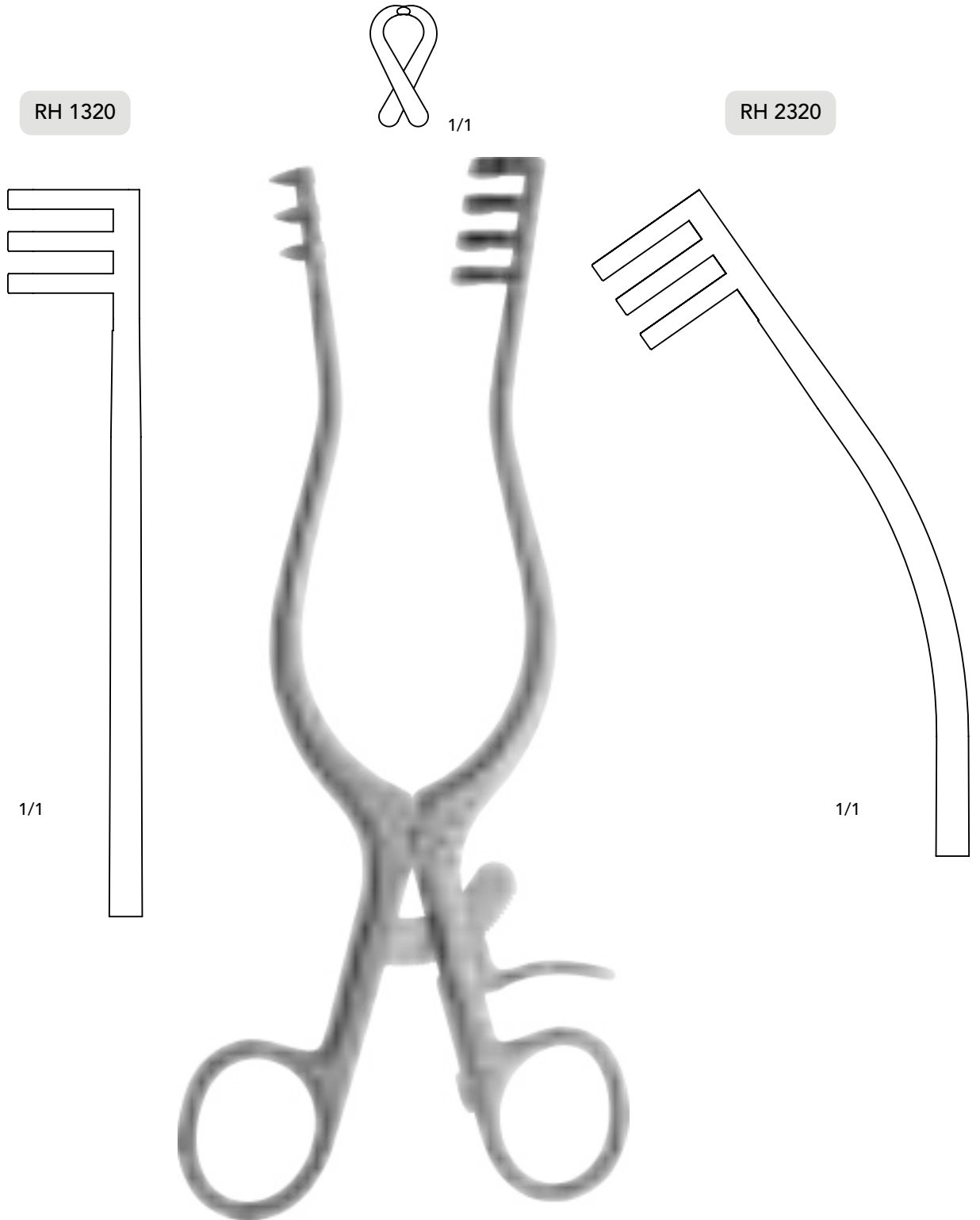

Henly Popliteal Self Retaining Retractor (Big) 8"

## Cooly Mitral Valve Retractors



Size	L X W	Code
<b>Small</b>	35 x 25 mm	RC 2128
<b>Medium</b>	35 x 35 mm	RC 2228
<b>Big</b>	35 x 45 mm	RC 2328

Cooly Mitral Valve Retractors, Right

## Cooly Mitral Valve Retractor



Size	L X W	Code
<b>Small</b>	25 x 25 mm	RC 3128
<b>Medium</b>	25 x 35 mm	RC 3228
<b>Big</b>	25 x 45 mm	RC 3328

Cooly Mitral Valve Retractors, Left

## Kocher - Langenbeck Retractor

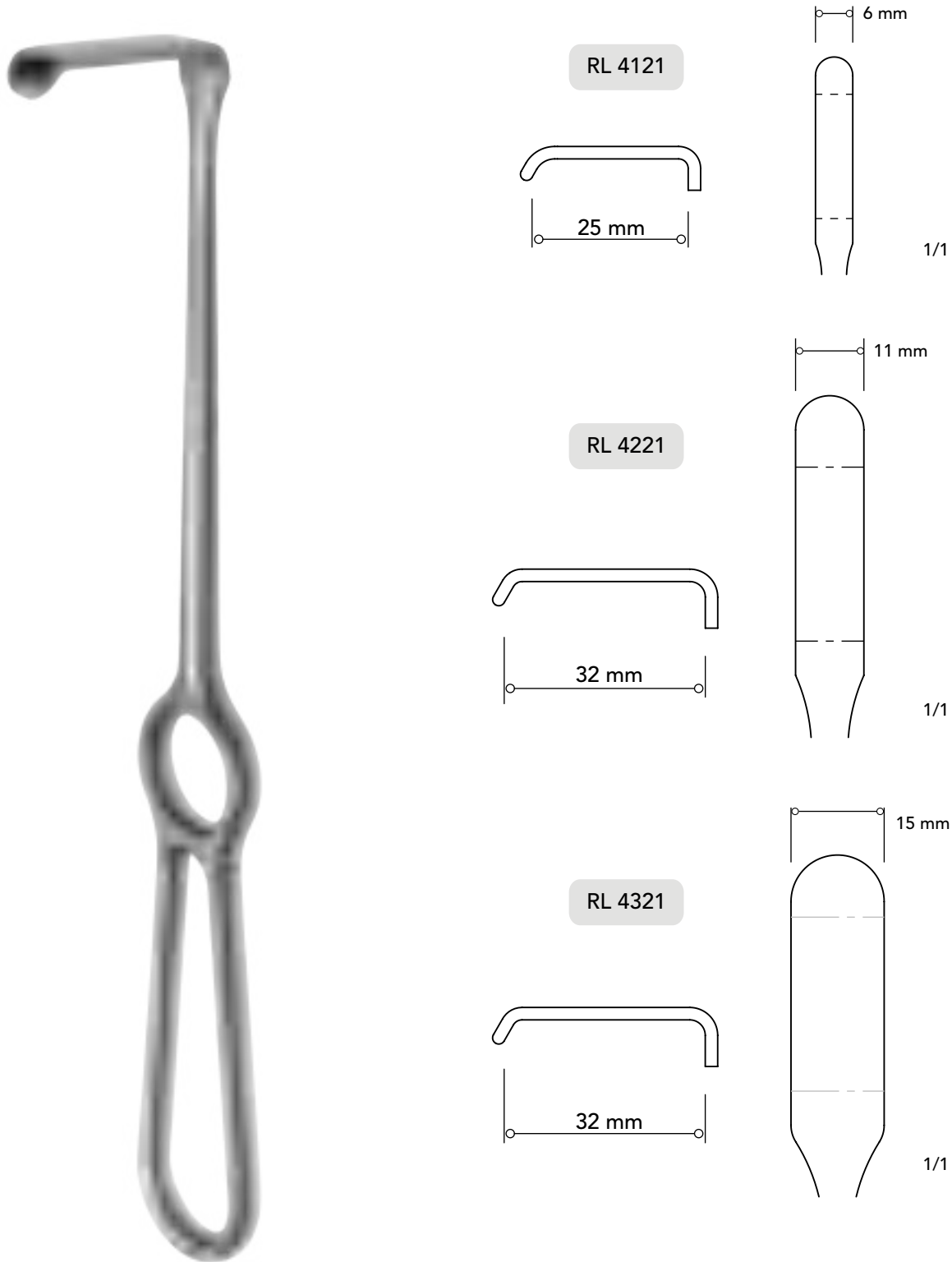

Kocher- Langenbeck Retractors



## Baby - Langenbeck Retractor



RL 4118

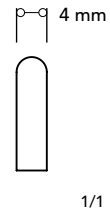
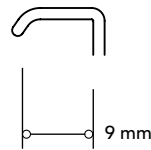

RL 4218

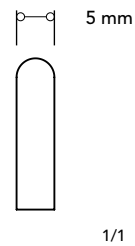
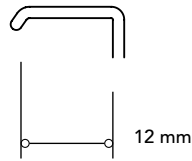

RL 4318

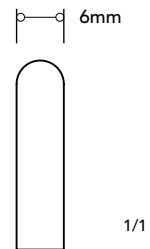
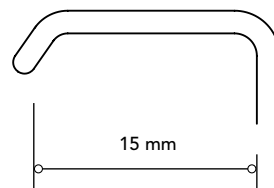

Baby- Langenbeck Retractors

## Aortic Valve Retractors



Size	L X W	Code
Small	13 x 22 mm	RC 4127
Medium	17 x 24 mm	RC 4227
Big	30 x 28 mm	RC 4327

Aortic Valve Retractors



	RV 5120		
3 mm			1/1
	RV 5220		
6 mm			1/1
	RV 5320		
8 mm			1/1
	RV 5420		
10 mm			1/1
	RV 5520		
12 mm			1/1

### VSD Retractors

# RETRACTORS

## Harrington Retractors

RA 6130



45 mm

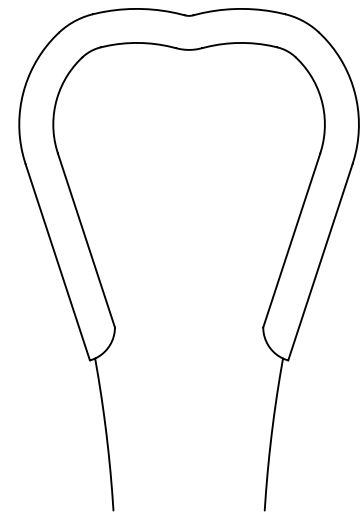

Medium

1/1

RA 6230

65 mm

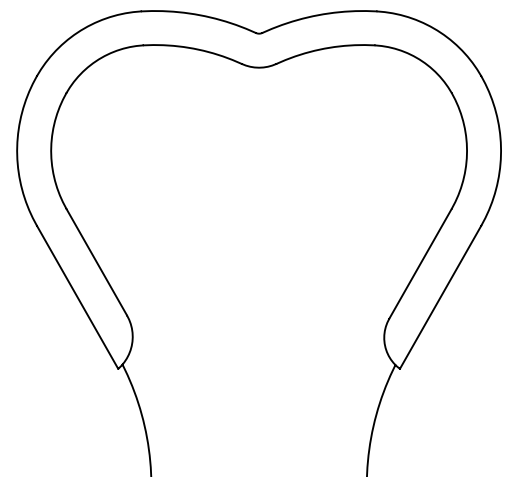

Big

1/1

Harrington Retractors 12"

RE 3028



**Small**  
(26 mm)

RE 4034



**Medium**  
(38 mm)

RE 5034



**Big**  
(50 mm)

### Davers Retractors 12"

RD 7120

RD 7222

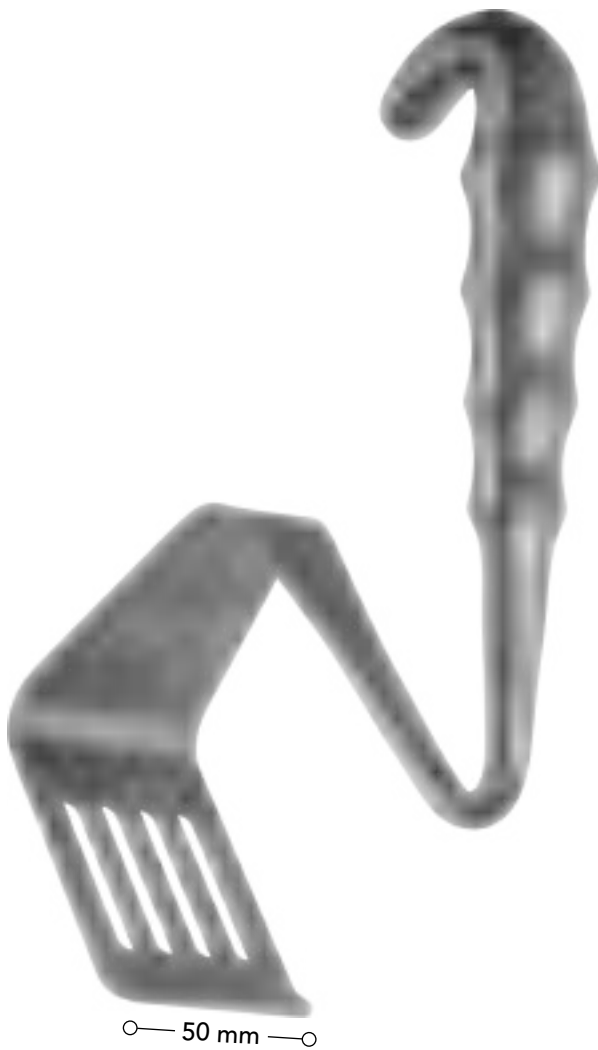

Small

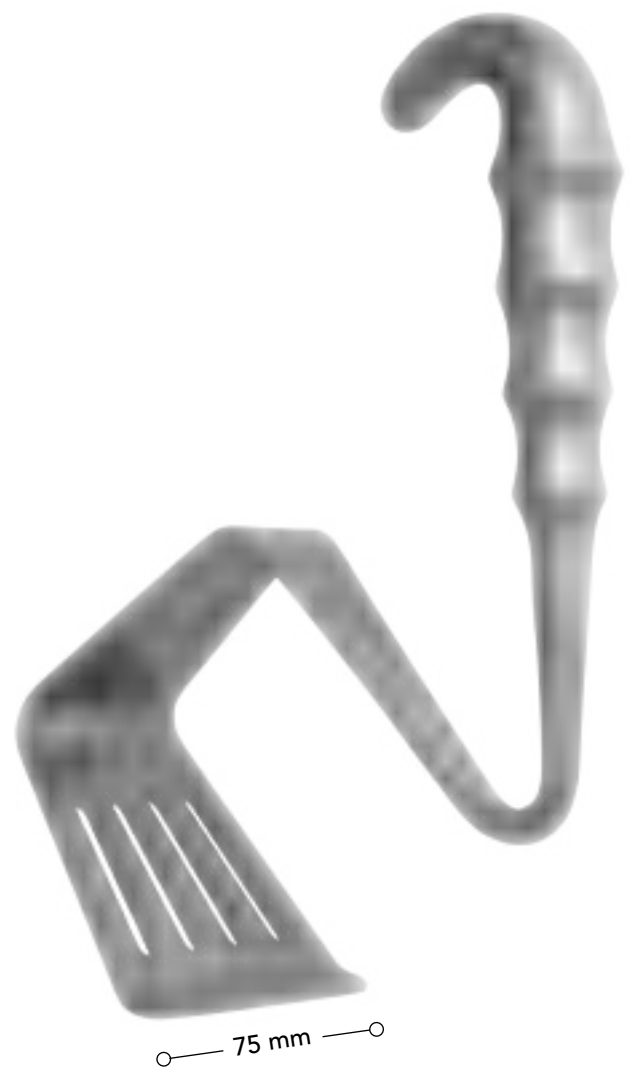

Big

### Davidson Scapula Retractors 8"

# RETRACTORS

## Allison Lung Retractors

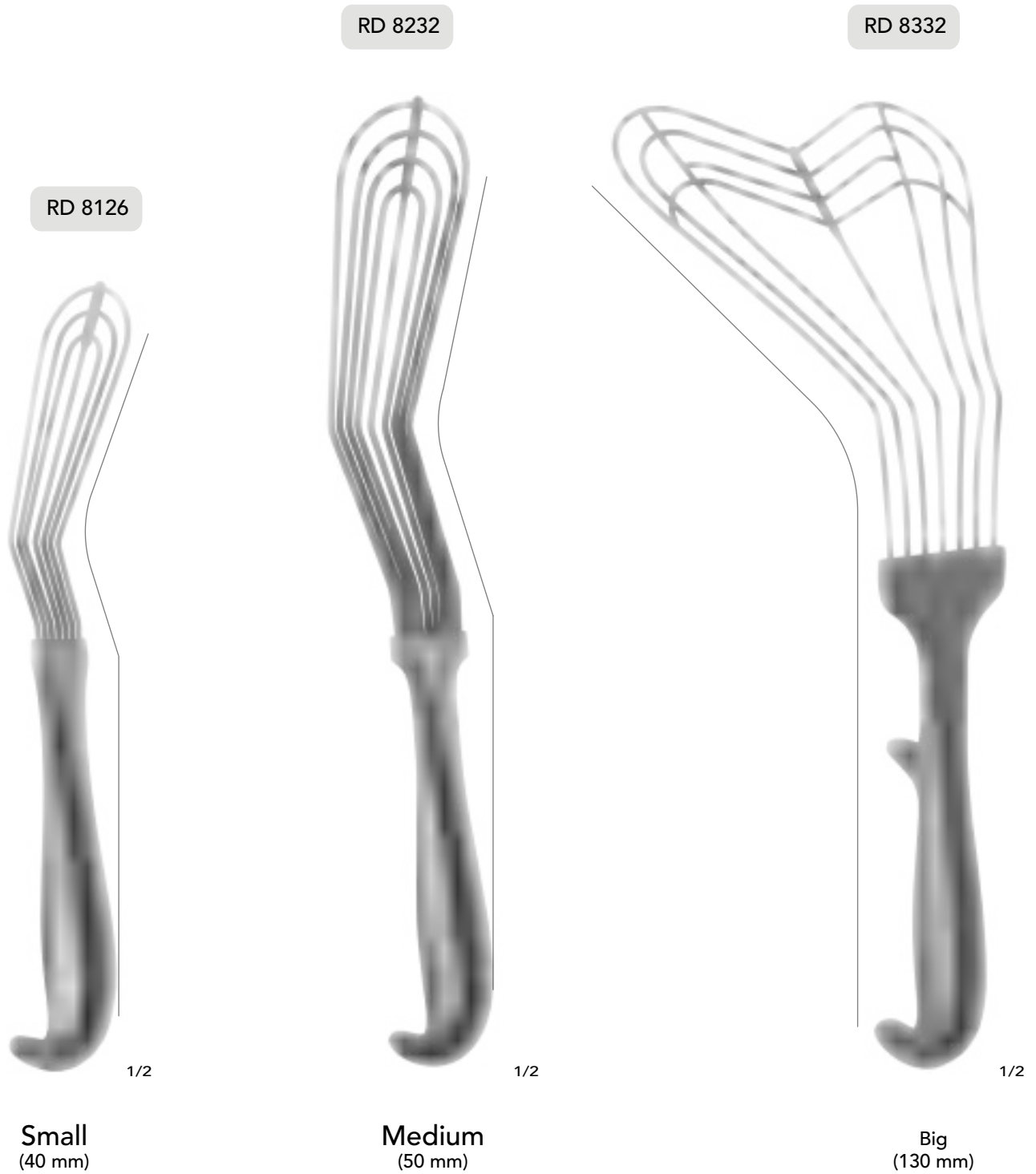

### Allison Lung Retractors

# RETRACTORS

## Mories Retractors

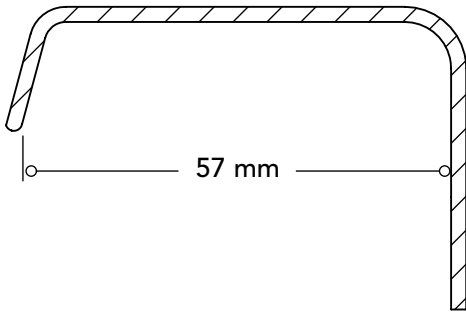

1/2

RO 1100

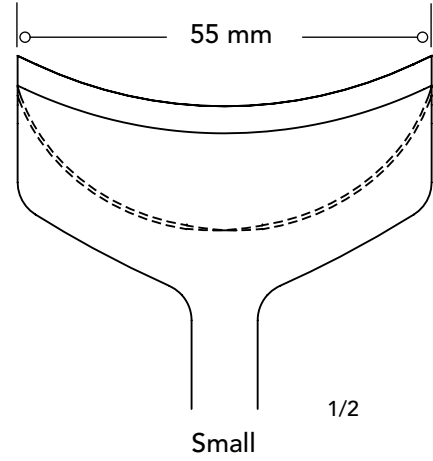

RO 1200

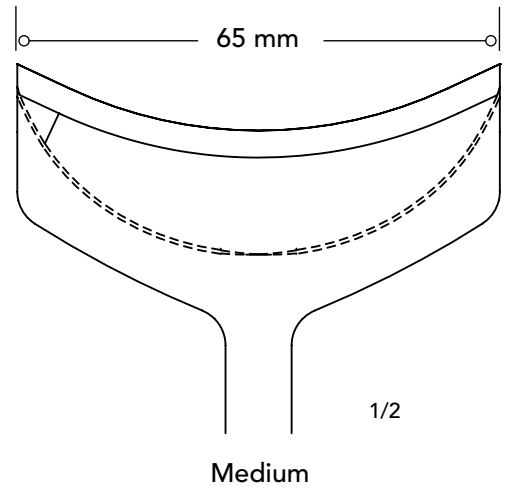

RO 1300

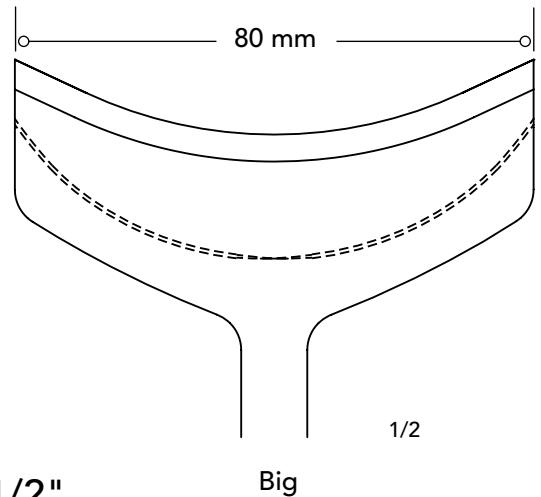

Mories Retractors 9 1/2"



# RETRACTORS

## Rack Retractors



RR 9120

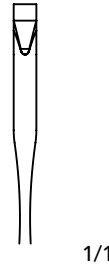

RR 9220

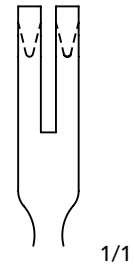

RR 9320

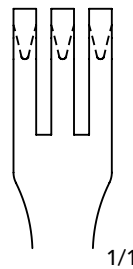

RR 9420

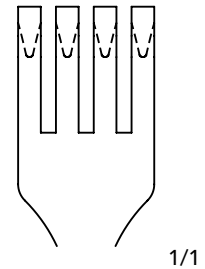

RR 9520

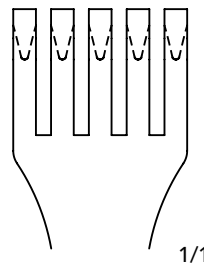

RR 9620

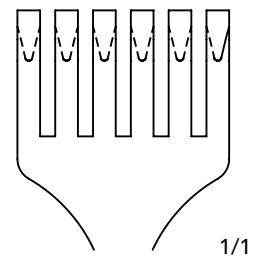

### Rack Retractors

RR 9316



Baby Rack Retractor Three Hooks

RS 0318



Muller-Senn/Cats Paw Retractor

RZ 0220

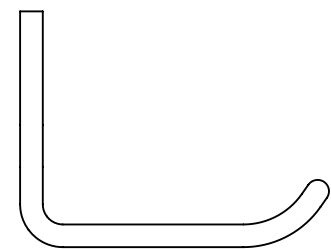
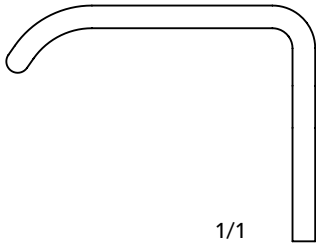

Zereny Retractor

## Epicardial Fat Retractors

RE 0104



1/1

Single Prong 1.5"

RE 0106



1/1

Single Prong 2"

RE 0204



1/1

Two Prongs 1.5"

RE 0206



1/1

Two Prongs 2"

RE 0304



1/1

Three Prongs 1.5"









RE 0306



1/1

Three Prongs 2"

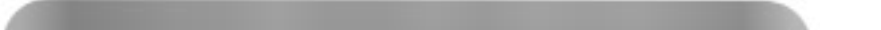
## Epicardial Fat Retractors

RI 0005		5 mm
RI 0010		10 mm
RI 0015		15 mm
RI 0020		20 mm
RI 0025		25 mm
RI 0030		30 mm
RI 0035		35 mm
RI 0040		40 mm
RI 0045		45 mm
RI 0050		50 mm

### Malleable / Ribbon Retractors

HN 1120

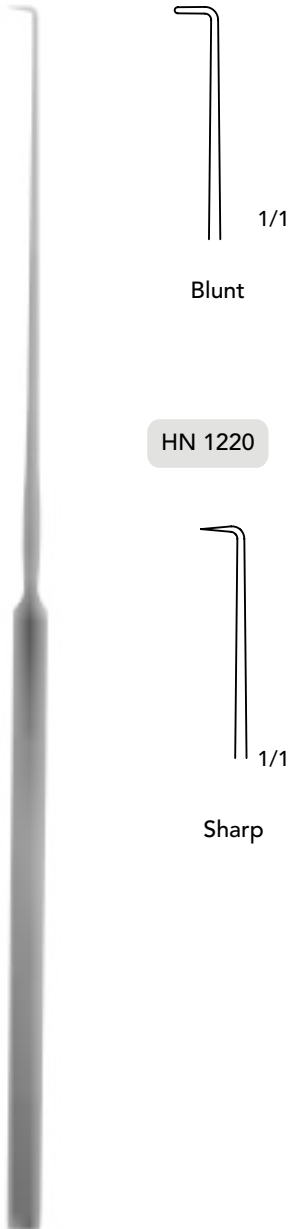

Nerve Hook

HT 4120



Tracheal Hook

HS 1318



Skin Hook

HN 1220

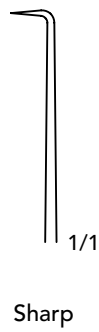

## Hooks



HM 2125

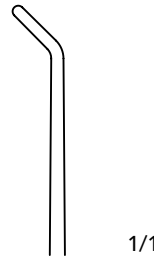

45 degree

HM 2225

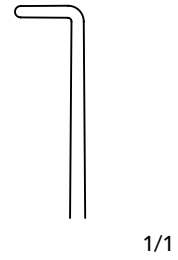

90 degree

HM 2325

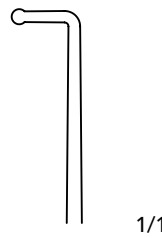

90 degree Ball Tip

HM 2425

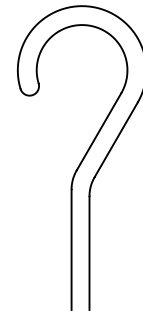

Question Mark Tip

### Mitral Hooks



HG 3125



1/1

1.5 mm Small

HG 3225



1/1

2.0 mm Medium

HG 3325



1/1

2.6 mm Big

Snigger Rods





## Cardiotomy Suction Tubes

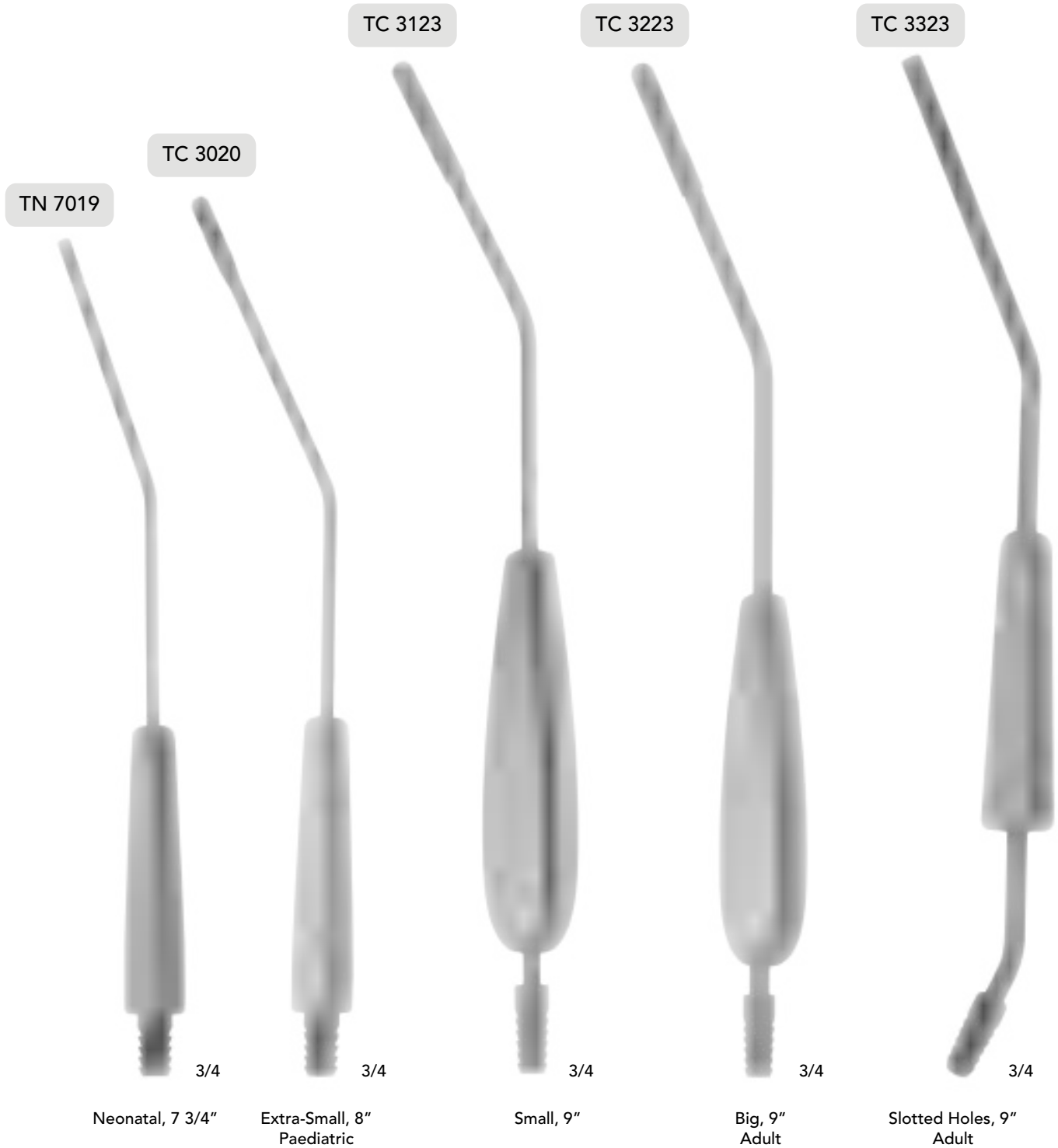

### Cardiotomy Suction Tubes

## Rough Suction Tubes



## Suction Tips

TS 6118

Fraizer Suction Tip # 1

TS 6218

Fraizer Suction Tip # 2

TS 6318

Fraizer Suction Tip # 3

TS 6418

Fraizer Suction Tip # 4

Fraizer Suction Tips 7", 180 mm

## Suction Tips & Cannulas

### Bullet Suction Tips

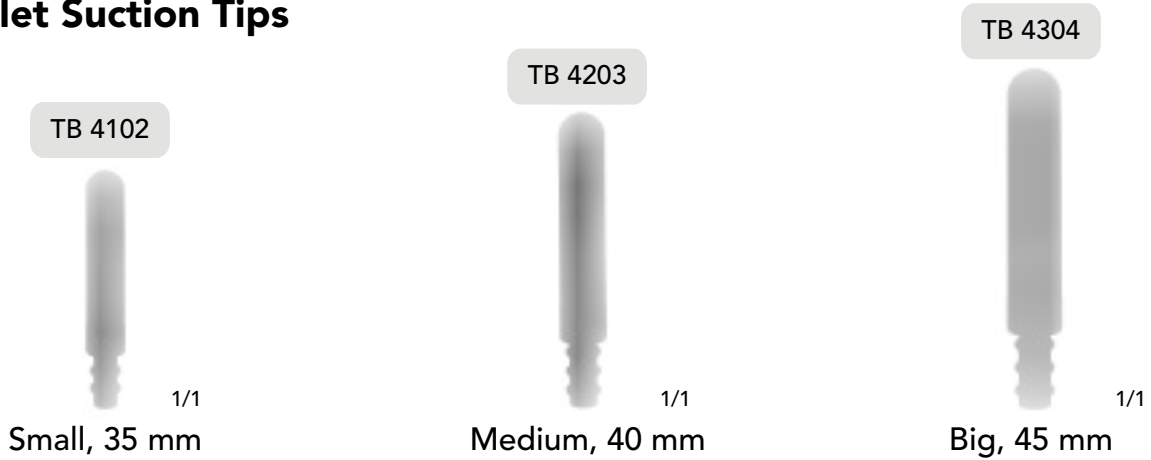

### Heparin / Irrigation Cannula

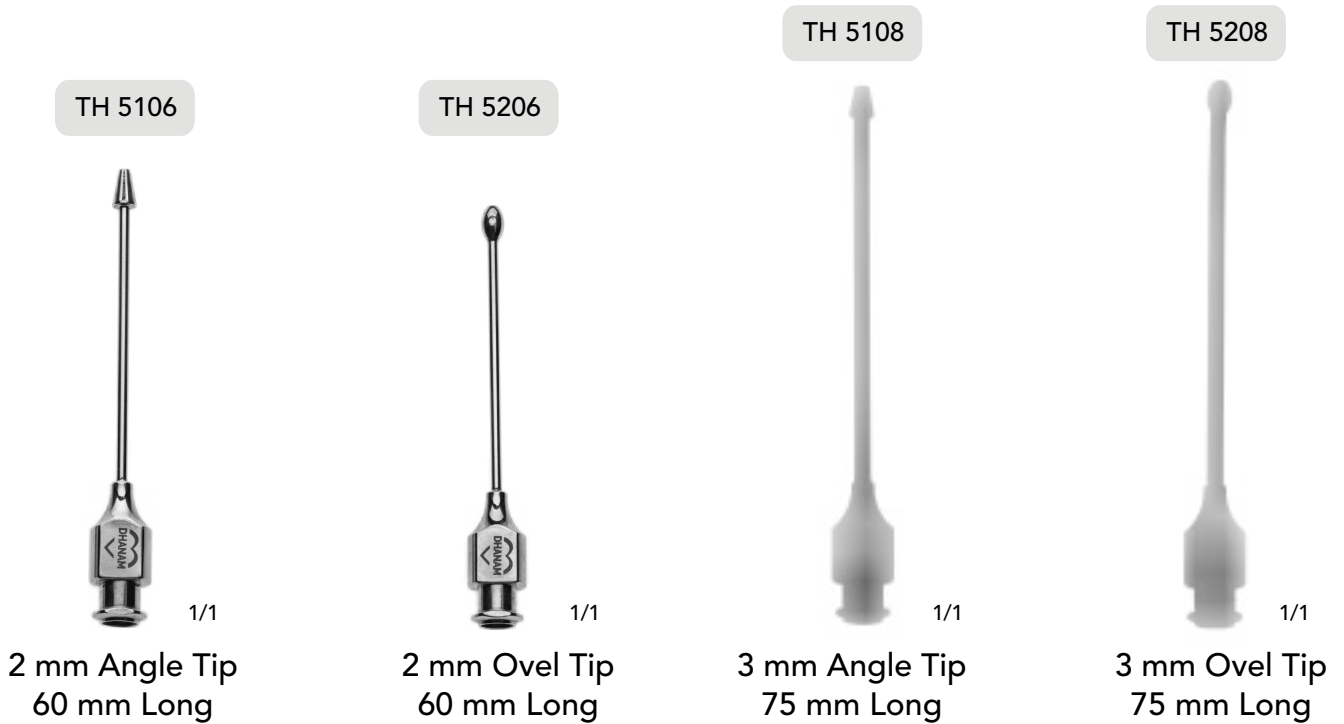

### C-Needle







## Bone Cutters

OB 1223



3/4

**Bone Cutting Forceps**  
9", 230 mm

ON 2123



3/4

**Bone Nibbler**  
9", 230 mm

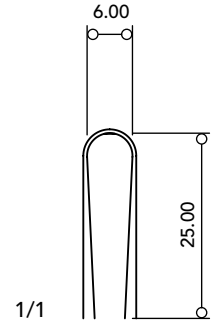



## Bone Cutters

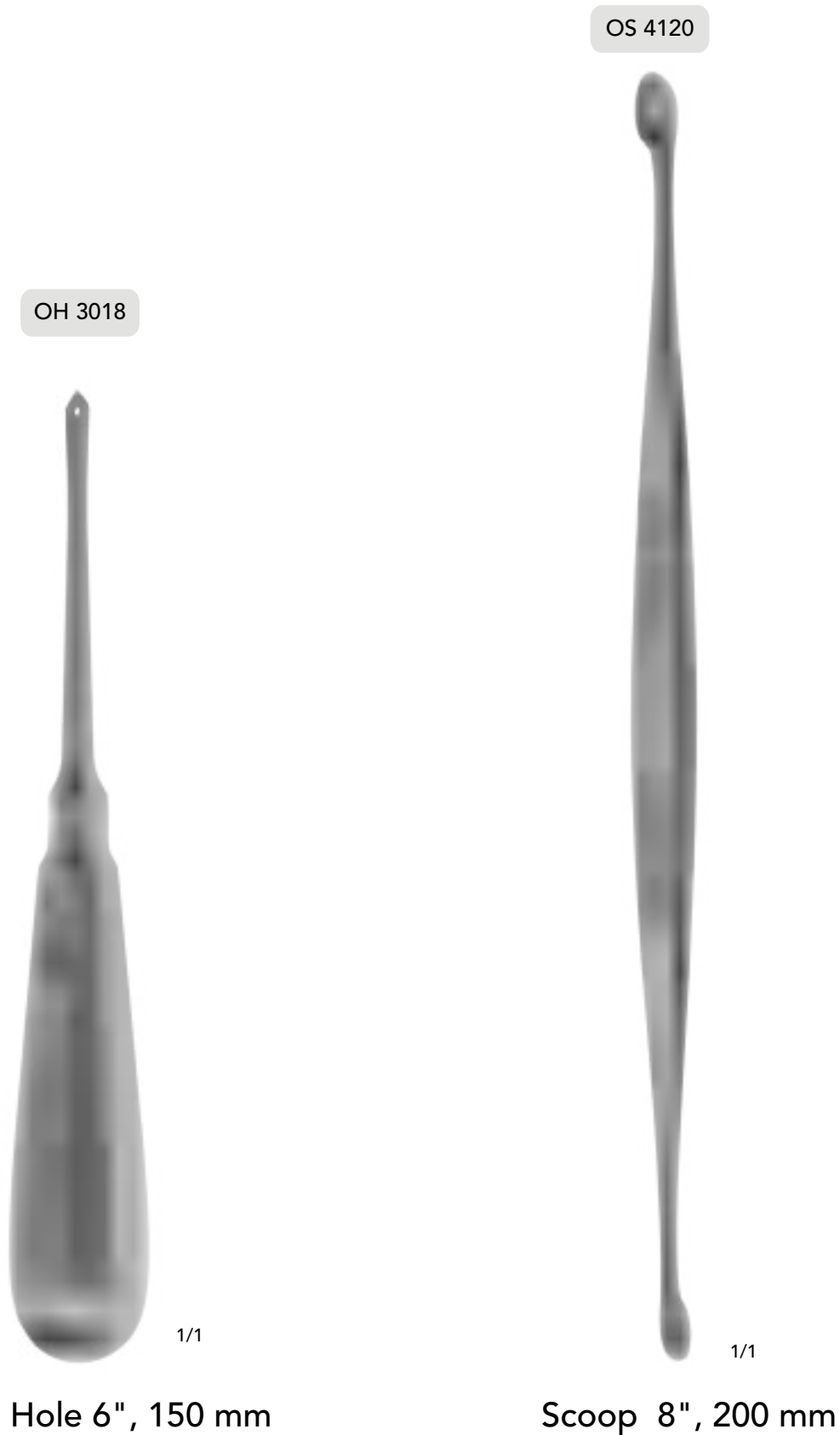

OD 5120

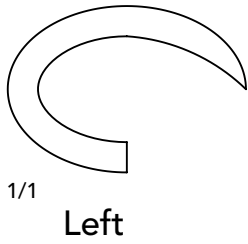

OD 5220

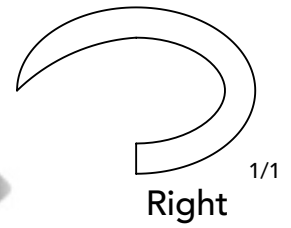

Doyen Raspatories 6", 150 mm

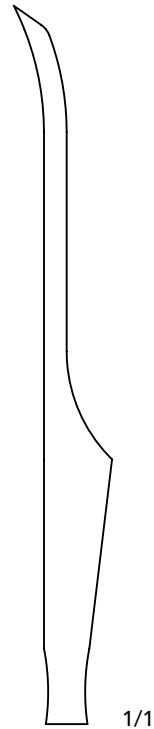

OL 0521

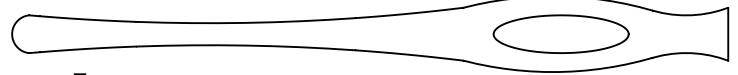

5 mm

1/1

OL 1021

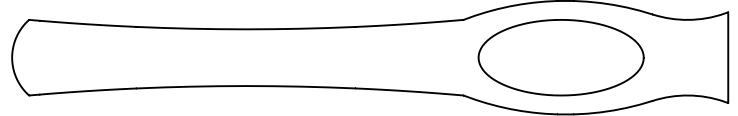

10 mm

1/1

OL 1521

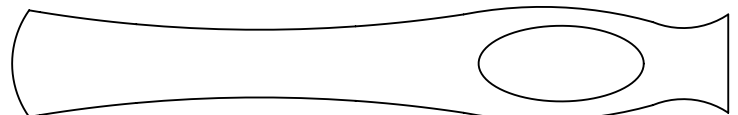

15 mm

1/1

OL 2021

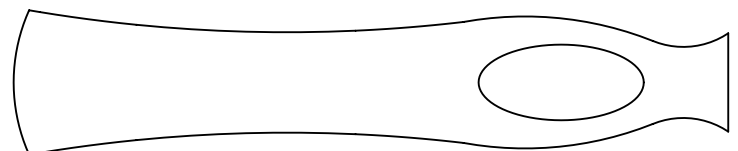

20 mm

1/1

OL 2521

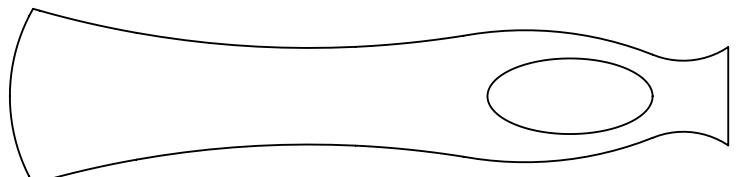

25 mm

1/1

Lambotte Bone Raspatories 9", 230 mm

## Elevators

OE 0121

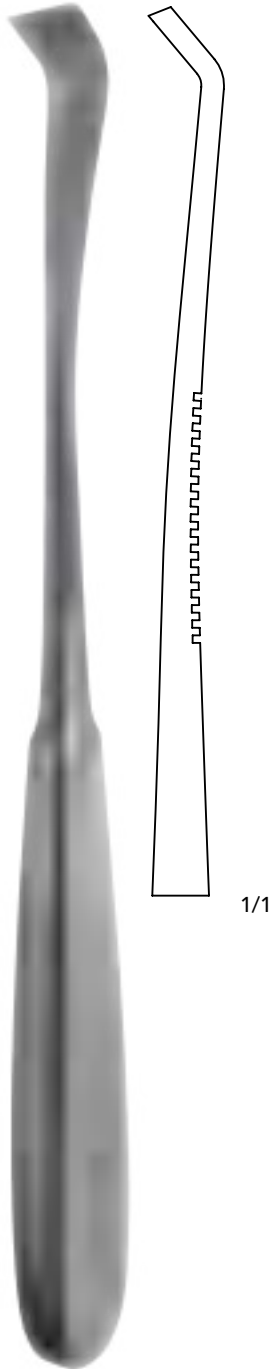

Forward

OE 0221

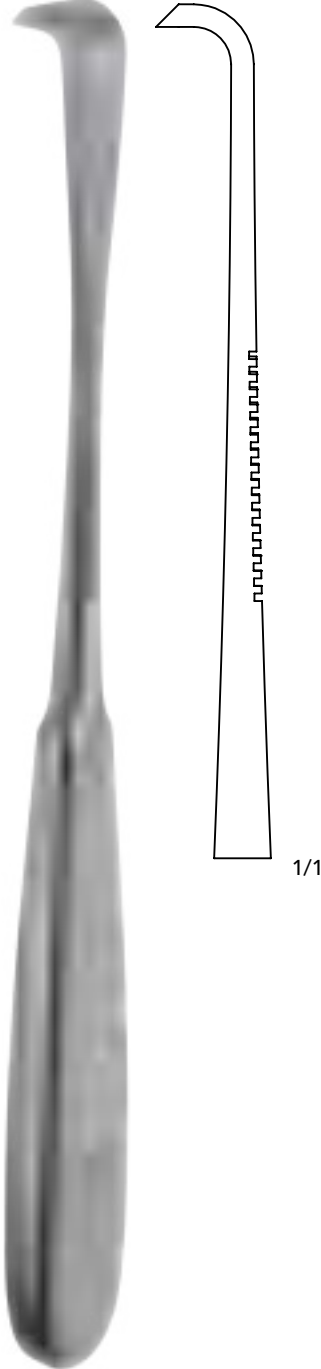

Reverse

OE 0321

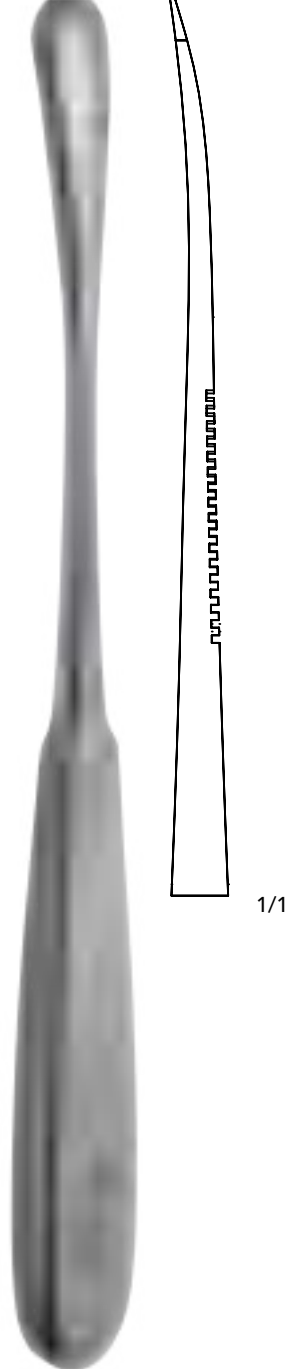

Curved

Semb Bone Raspatories  
9", 230 mm (13mm Width)

OA 7118

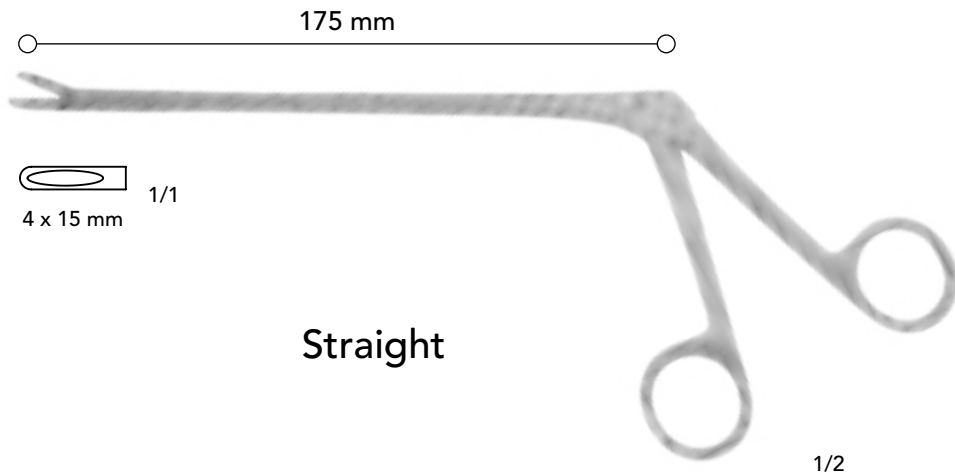

OA 7218

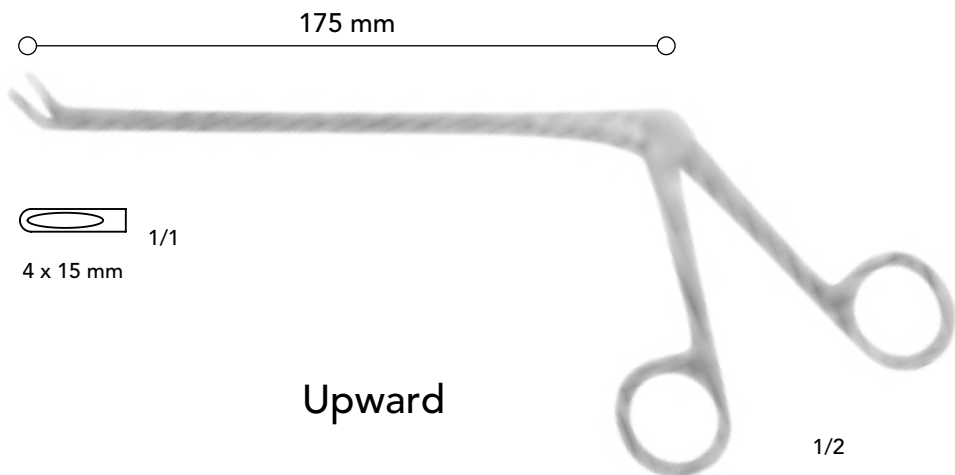

OA 7318

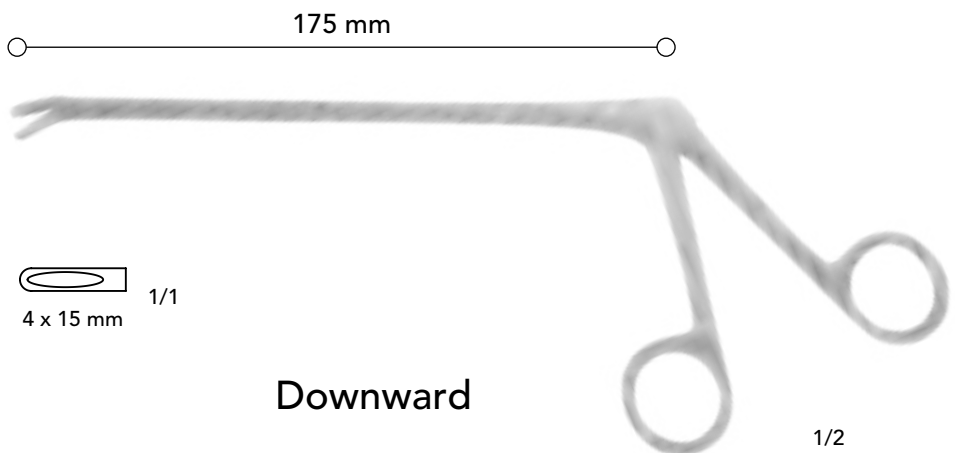

Aortic Valve Rongeurs 10", 250 mm









## Needle Holders



Round Handle Micro Needle Holders  
(With Lock) - Stainless Steel







Tip Size	0.8 mm	1.0 mm	1.3 mm	1.4 mm	1.6 mm
					
Suture Size	8 / 0	7 / 0	6 / 0	5 / 0	4 / 0
6"	CN 81115	CN 71115	CN 61115	CN 51115	CN 41115
7"	CN 81118	CN 71118	CN 61118	CN 51118	CN 41118
8 ¼"	CN 81121	CN 71121	CN 61121	CN 51121	CN 41121
9"	CN 81123	CN 71123	CN 61123	CN 51123	CN 41123
10"	CN 81125	CN 71125	CN 61125	CN 51125	CN 41125



## Needle Holders





Round Handle Micro Needle Holders  
(With Lock) - Titanium

Tip Size	0.8 mm	1.0 mm	1.3 mm	1.4 mm	1.6 mm
					
Suture Size	8 / 0	7 / 0	6 / 0	5 / 0	4 / 0
6"	CN 81115T	CN 71115T	CN 61115T	CN 51115T	CN 41115T
7"	CN 81118T	CN 71118T	CN 61118T	CN 51118T	CN 41118T
8 ¼"	CN 81121T	CN 71121T	CN 61121T	CN 51121T	CN 41121T
9"	CN 81123T	CN 71123T	CN 61123T	CN 51123T	CN 41123T
10"	CN 81125T	CN 71125T	CN 61125T	CN 51125T	CN 41125T

## Needle Holders





<b>Suture Size</b>	<b>2 / 0</b>
	
<b>Tip Size</b>	<b>2.0 mm</b>
<b>7 ½"</b>	CN 21119
<b>9"</b>	CN 21123
<b>10"</b>	CN 21125

**Round Handle Heavy Micro Needle Holders  
(With Lock) - Stainless Steel**

## Needle Holders



<b>Suture Size</b>	<b>2 / 0</b>
	
<b>Tip Size</b>	<b>2.0 mm</b>
<b>7 ½"</b>	CN 21119T
<b>9"</b>	CN 21123T
<b>10"</b>	CN 21125T





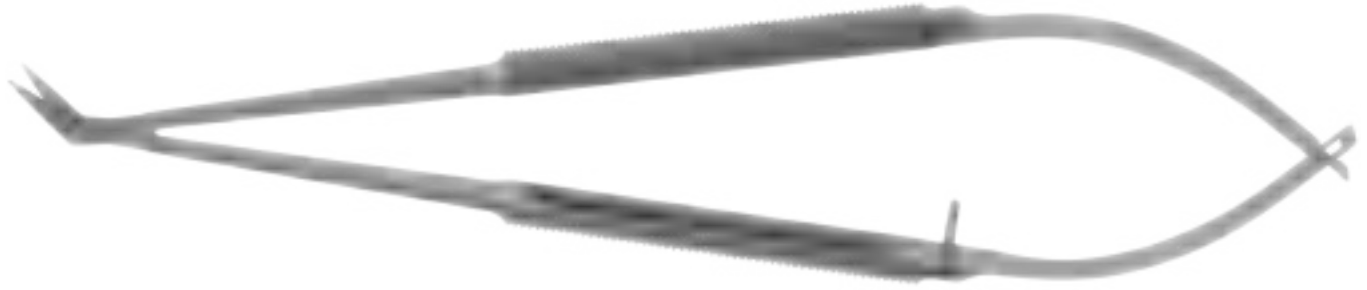

Round Handle Heavy Micro Needle Holders  
(With Lock) - **Titanium**



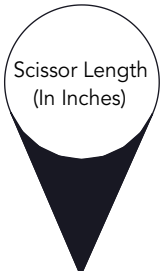



Round Handle Spring Potts Scissors - Stainless Steel

Cutting Angle		25°	45°	60°	90°	125°
						
LONG BLADE (10 mm)	7"	MSP 25118	MSP 45118	MSP 60118	MSP 90118	MSP 125118
	8"	MSP 25120	MSP 45120	MSP 60120	MSP 90120	MSP 125120
	9"	MSP 25123	MSP 45123	MSP 60123	MSP 90123	MSP 125123
SHORT BLADE (7 mm)	7"	MSP 25118S	MSP 45118S	MSP 60118S	MSP 90118S	MSP 125118S
	8"	MSP 25120S	MSP 45120S	MSP 60120S	MSP 90120S	MSP 125120S
	9"	MSP 25123S	MSP 45123S	MSP 60123S	MSP 90123S	MSP 125123S





SR 262518



SR 264518



SR 266018

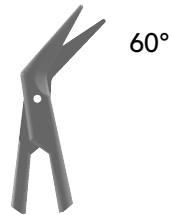

SR 269018



SR 2612518



Diethrich Potts Scissor (Ring Type) 7" (180 mm)





Debakey Scissors (Ring Type)



SS 210211

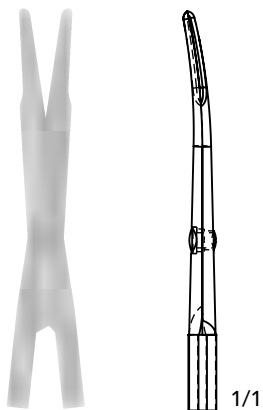

**Tenotomy**  
4 ½" (115 mm)

SM 250214



**Sharp Tip**  
5" (125 mm)

SM 230214

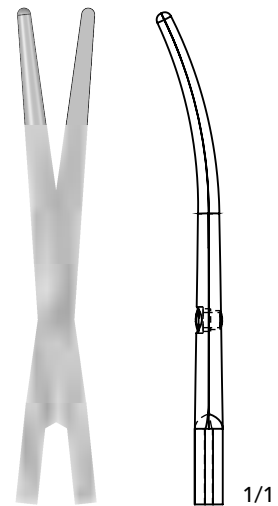

**Blunt Tip**  
5" (125 mm)

### Metzenbaum SuperCut Scissors (Small)



SR 250217

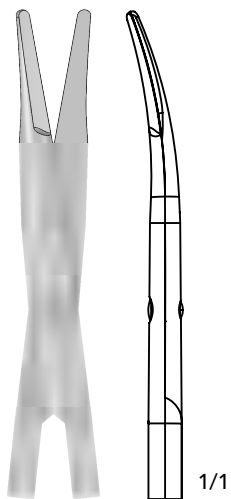

Ragnell

SM 230218

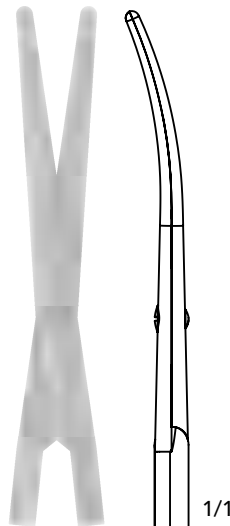

Blunt Tip

SM 250218

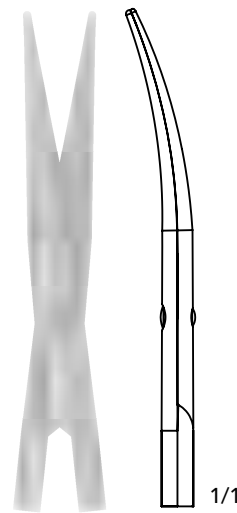

Sharp Tip

SL 250218

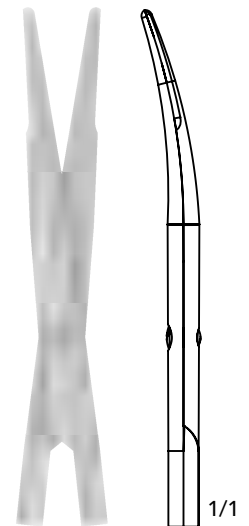

Tenotomy

Metzenbaum SuperCut Scissors 7" (180 mm)



SL 250223

SM 230223

SM 290223

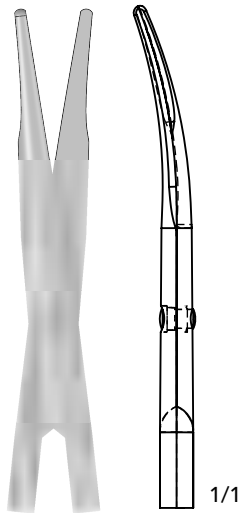

Lillehei - Potts

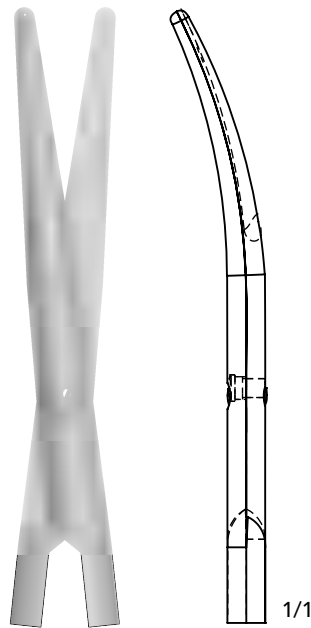

Heavy Blades

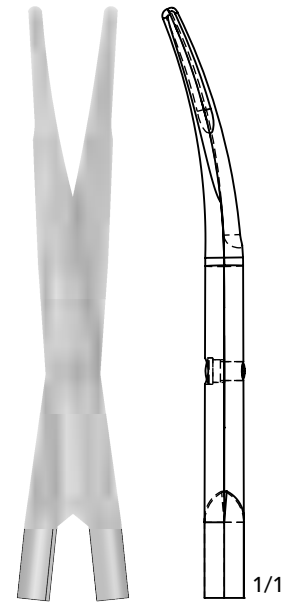

Fine Blades

**Metzenbaum Scissors Super Cut 9" (230 mm)**

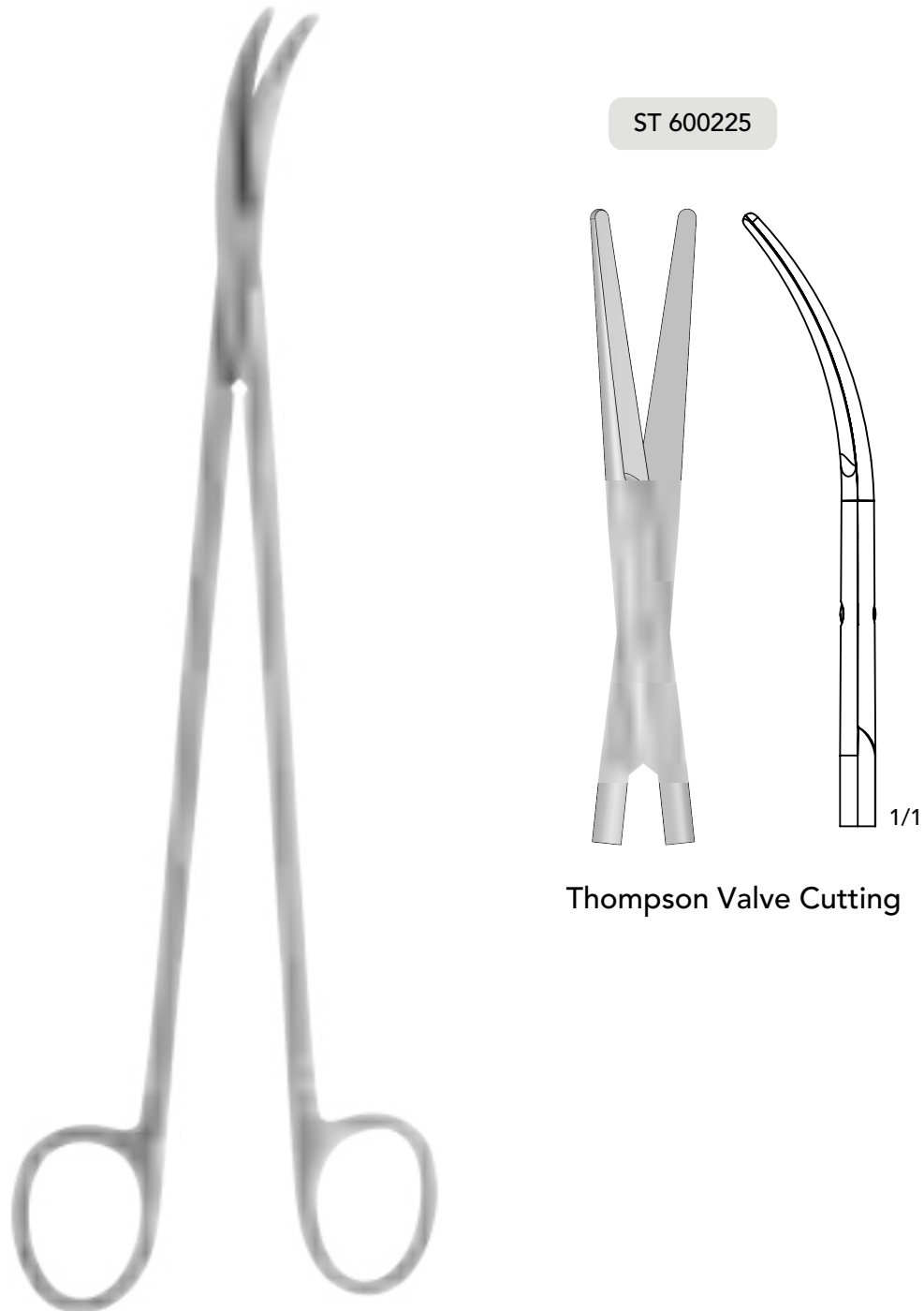

Thompson Valve Cutting Scissor Deep Curved Blades 10" (255 mm)

## Ring Tip Forceps

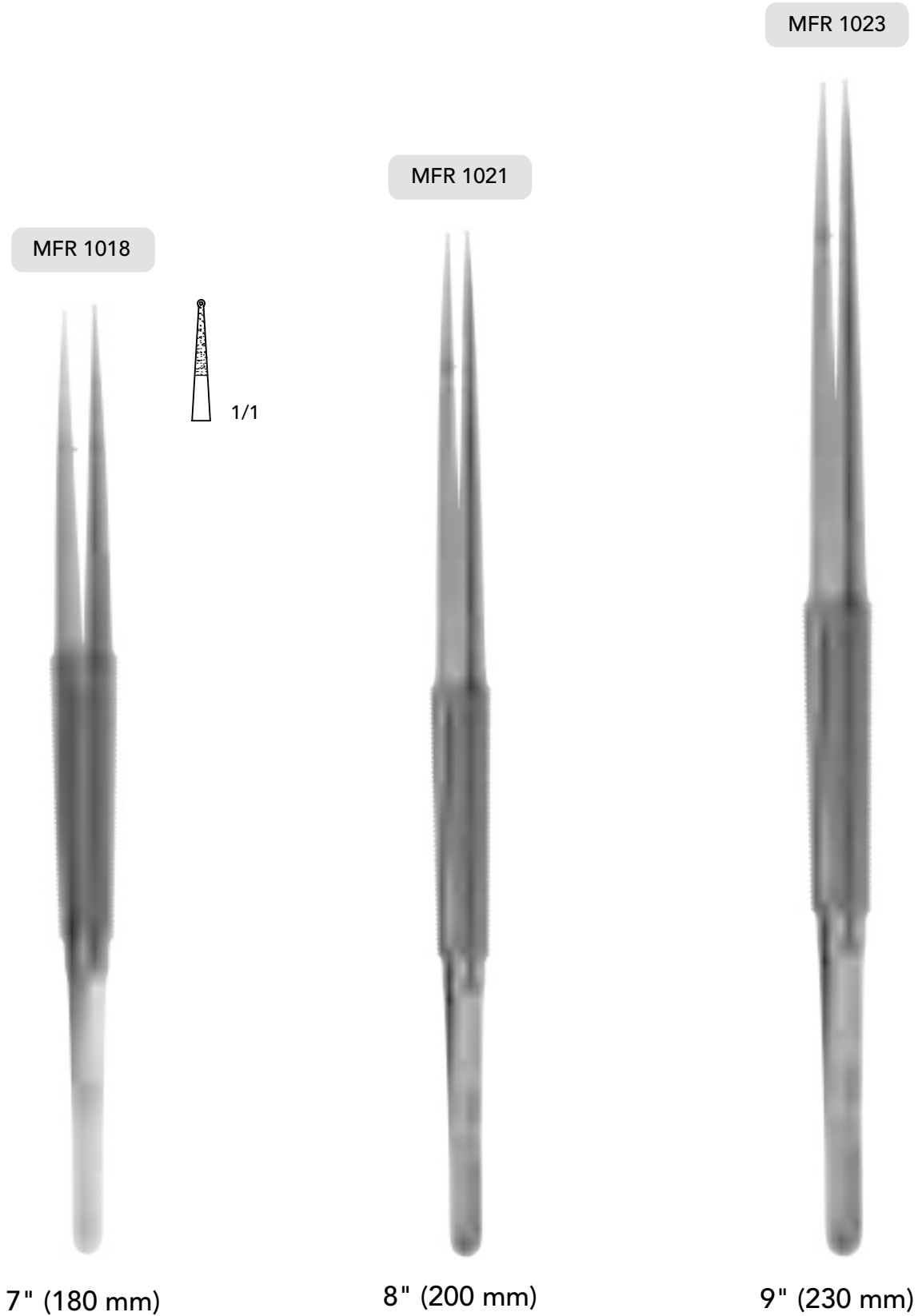

Micro Ring Tip Forceps Diamond Dusted



## Debakey Forceps

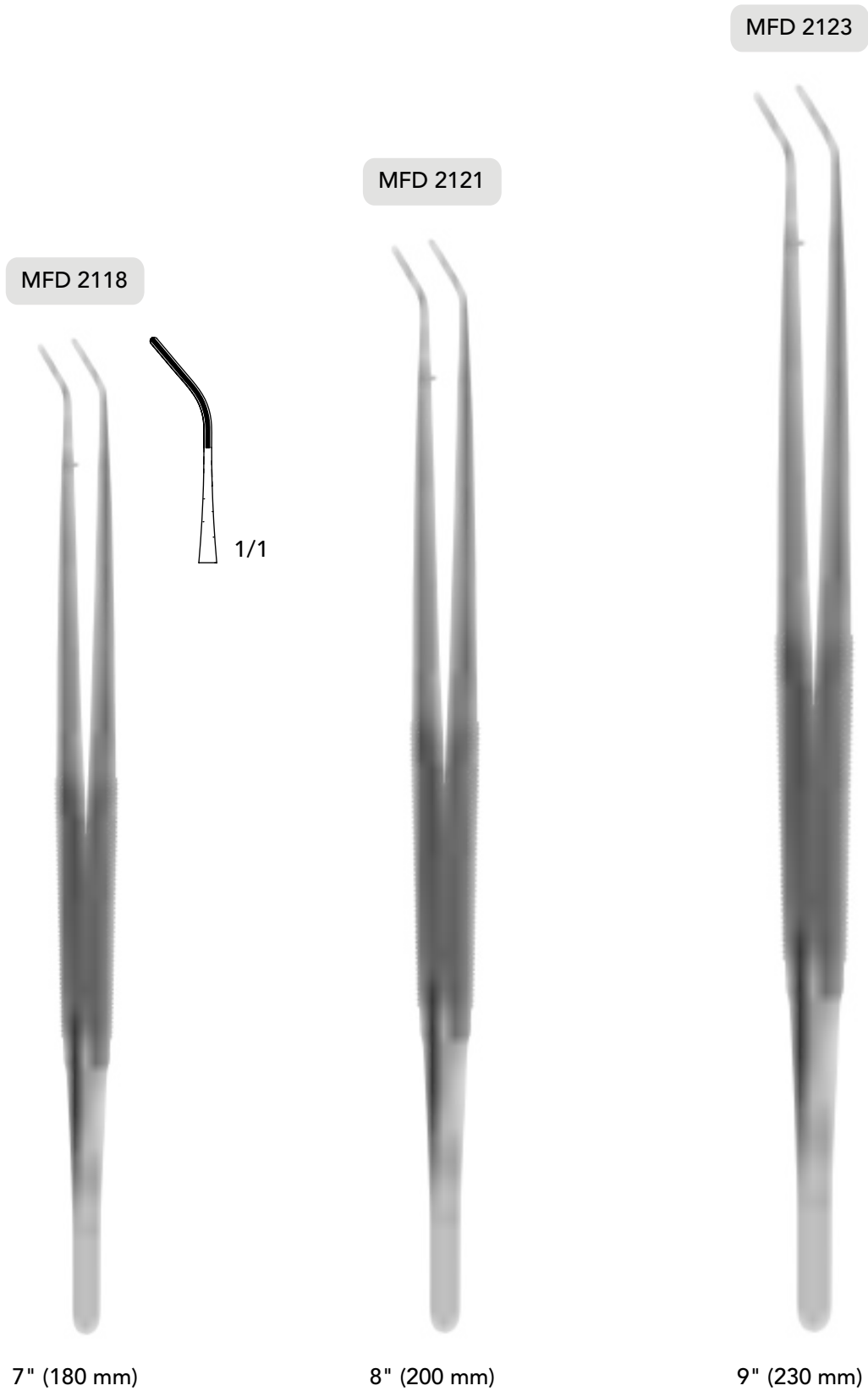

Micro Debakey Vascular Forceps 45° Angled



## Platform Forceps

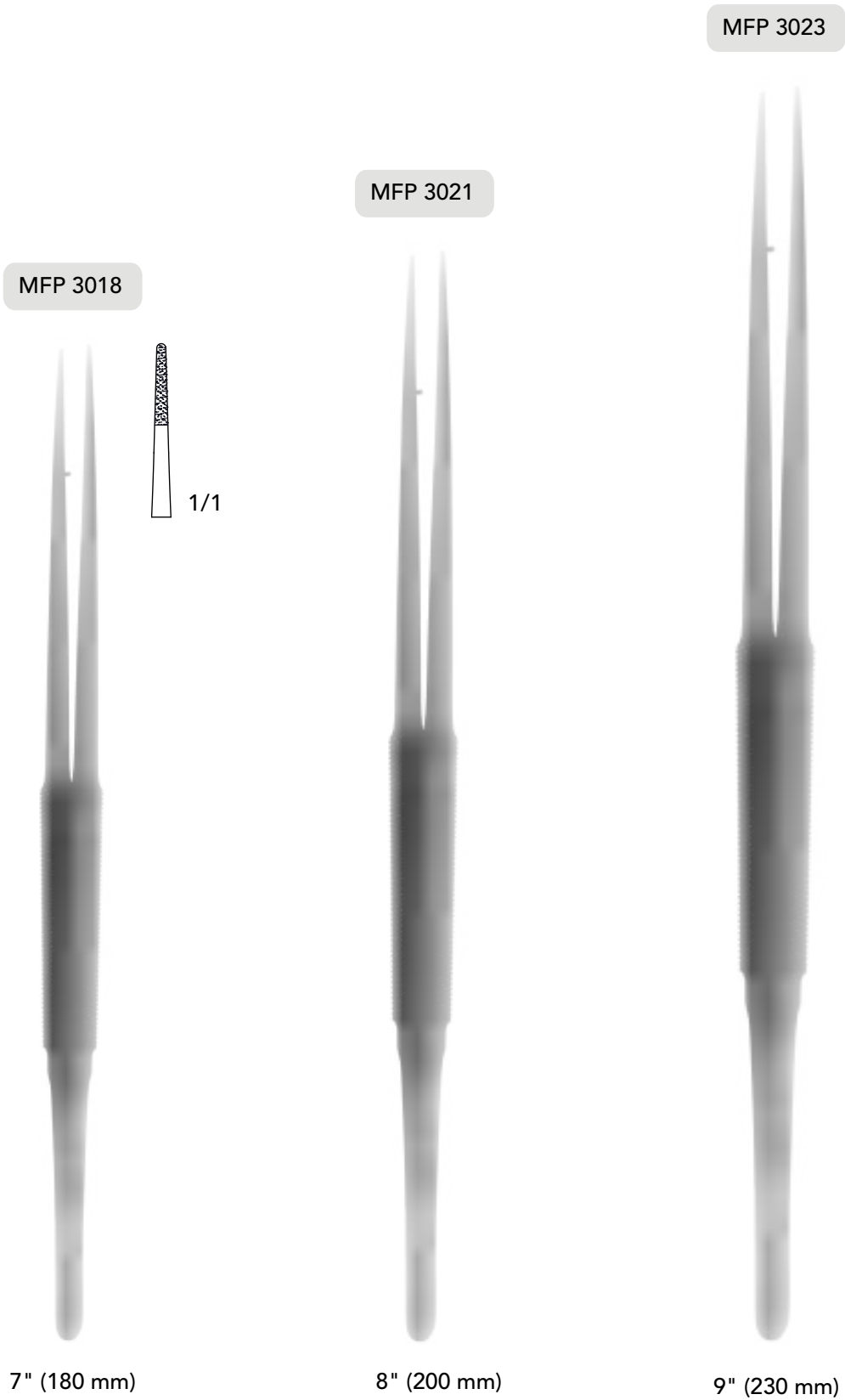

### Micro Platform Forceps Diamond Dusted

## Delicate Forceps

GF 158.175



7" (180 mm)

Gerald Forceps Delicate

GF 158.200



8" (200 mm)

MP 788.20



8" (200 mm)

Thumb Forceps (Diamond Dusted)

## Ring Tip Forceps

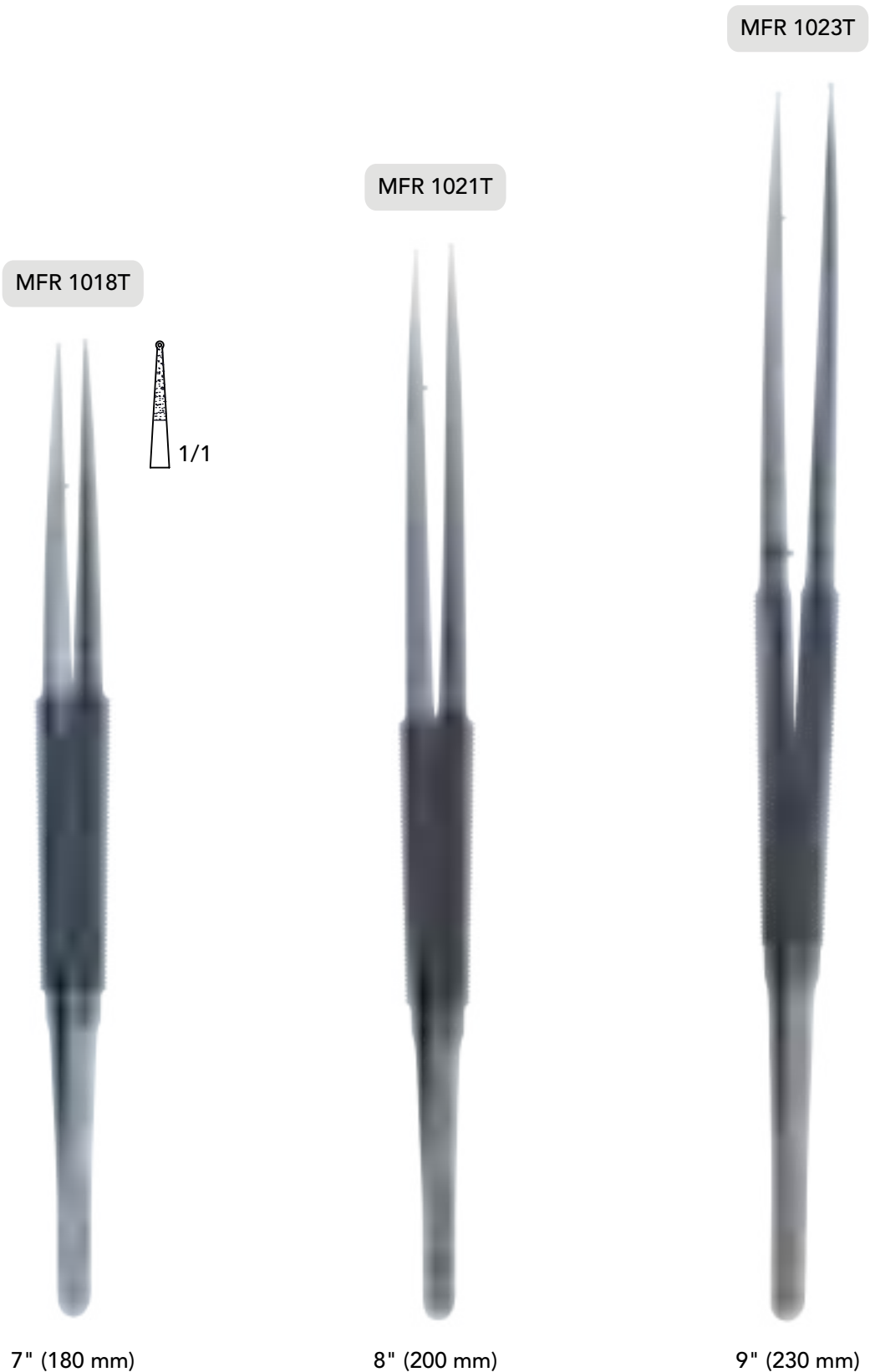

Micro Ring Tip Forceps Diamond Dusted - Titanium



## Debakey Forceps

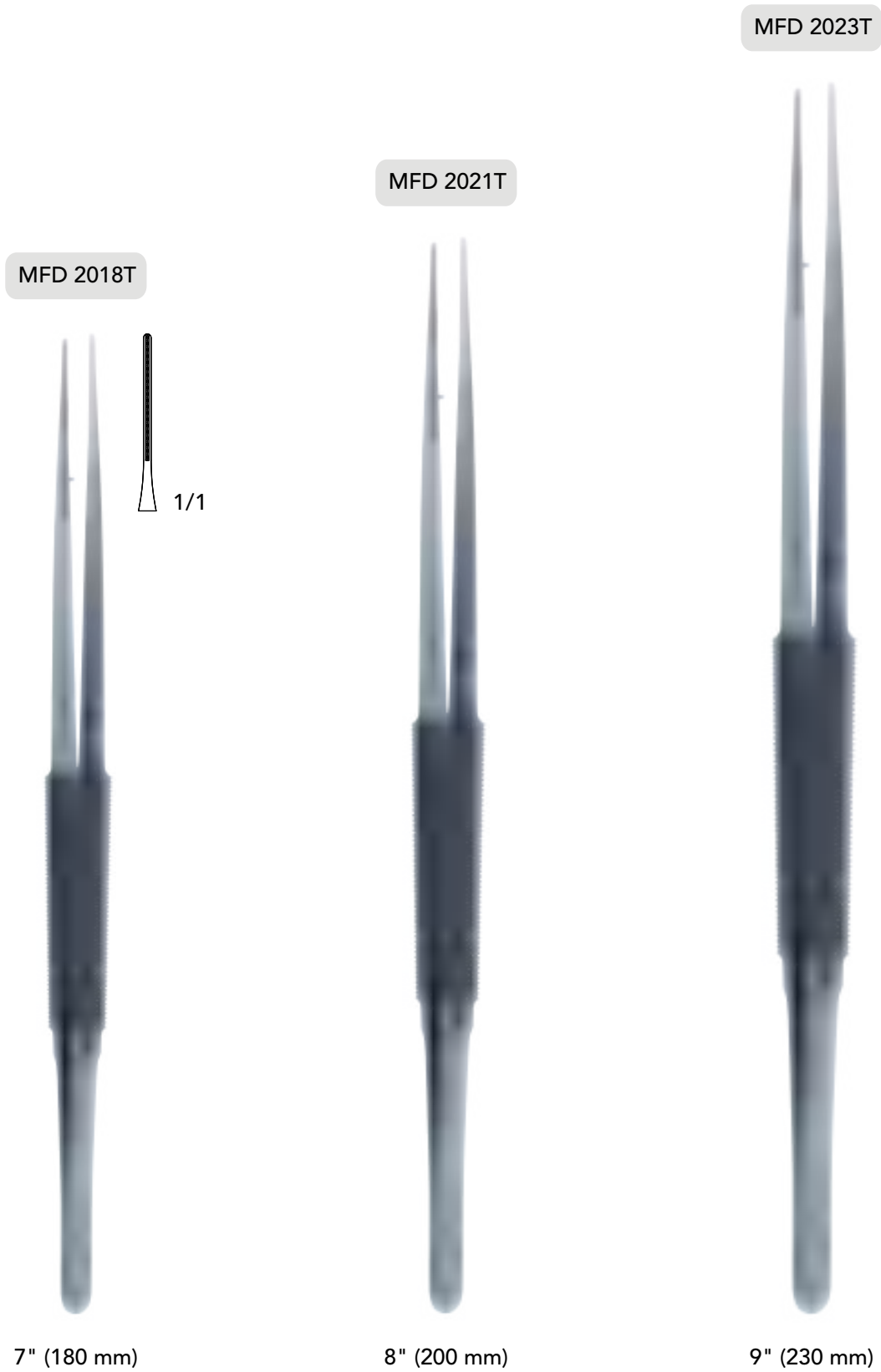

Micro Debakey Vascular Forceps - Titanium

## Debakey Forceps



Micro Debakey Vascular Forceps 45° Angled - Titanium



## Platform Forceps

MFP 3021T

MFP 3018T



1/1



7" (180 mm)

8" (200 mm)

Titanium Micro Platform Forceps Diamond Dusted



## Debakey Forceps



VF 39520

VF 39415



1mm Tip  
6" (150 mm)

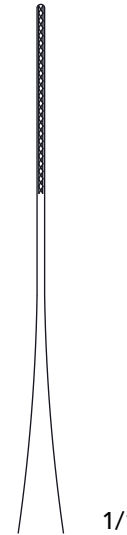

1mm Tip  
8" (200 mm)

VF 41220

VF 41115



1.5 mm Tip  
6" (150 mm)

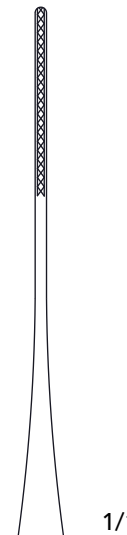

1.5 mm Tip  
8" (200 mm)

Debakey Vascular Forceps (1 mm & 1.5 mm Tips)

## Debakey Forceps

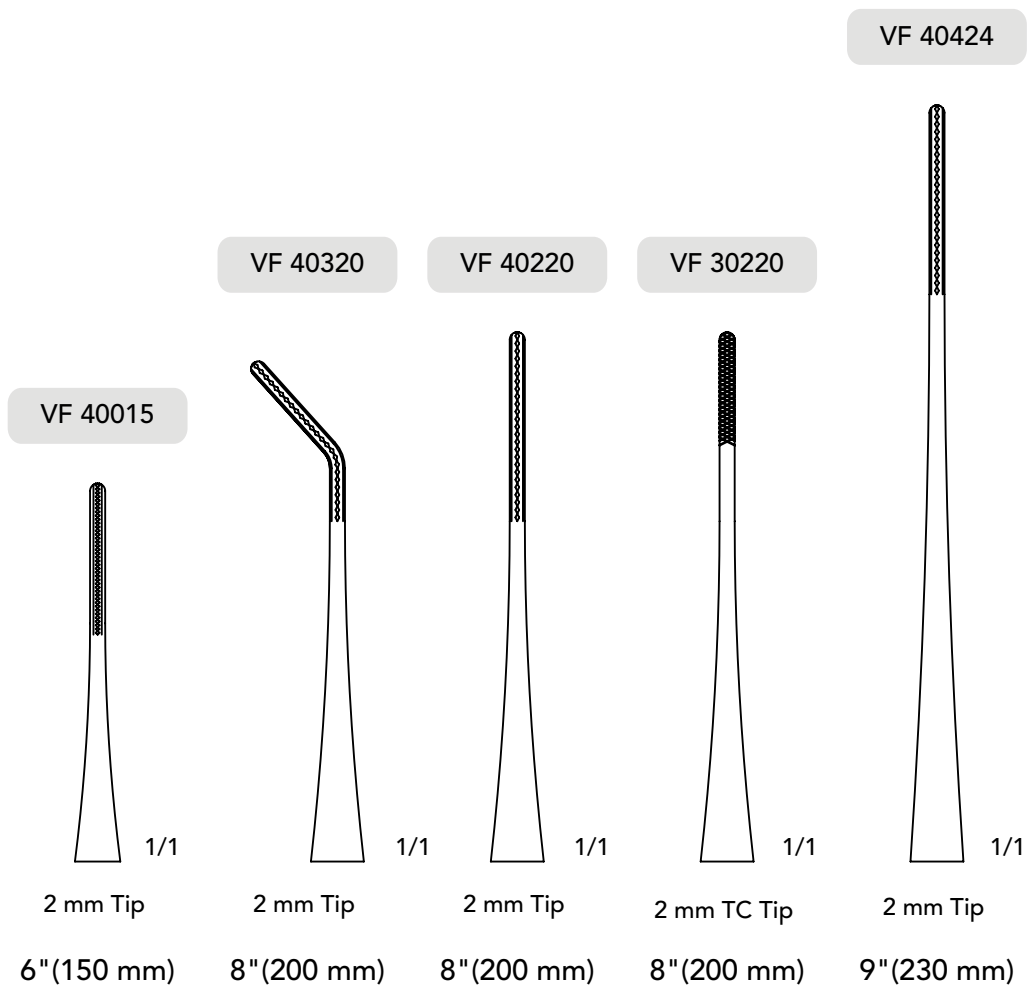

Debakey Vascular Forceps (2 mm Tips)

## Debakey Forceps

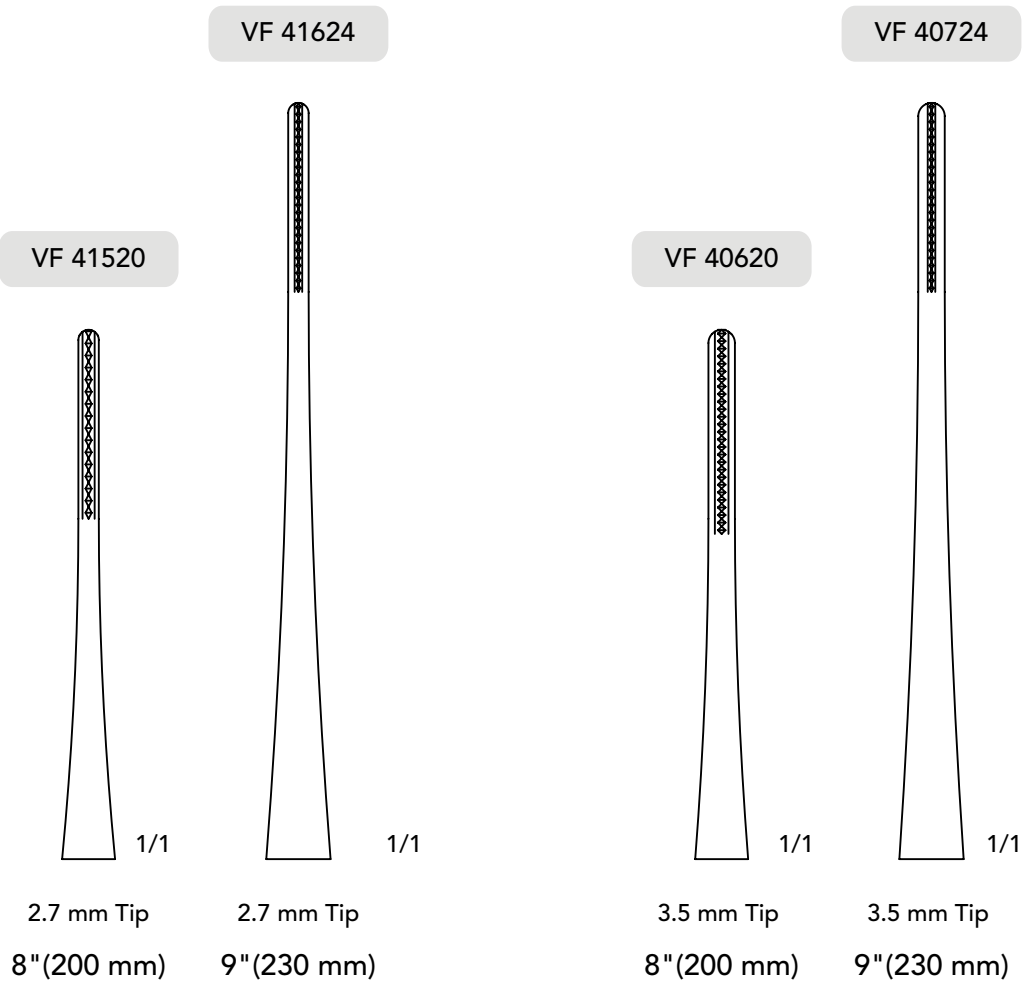
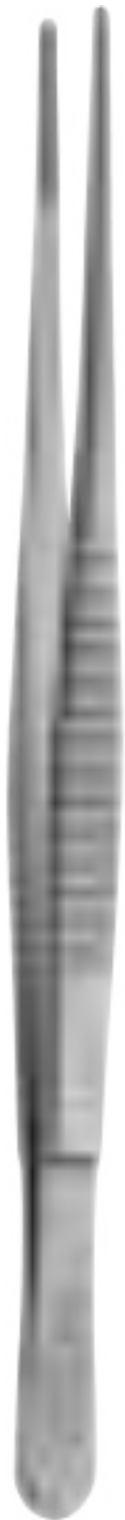

Debakey Vascular Forceps (2.7 mm & 3.5 mm Tips)

## Resano Forceps



VF 41024

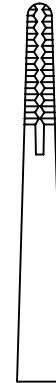

Resano Valve Forceps Multi Tooth Tip 9" (230 mm)  
(For Heart Valve Removal)

## Bulldog Clamps

BC 1105T

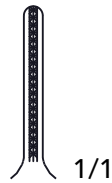

Straight

BC 1205T

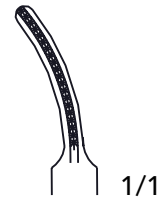

Curved

BC 1305T

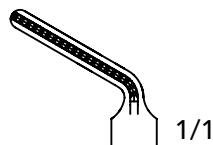

Angled

BC 3005

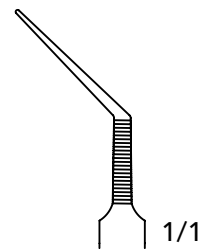

Spikey (Stainless Steel)

Debakey Bulldog Clamps 3" (75 mm) - Titanium

## Coronary Probes

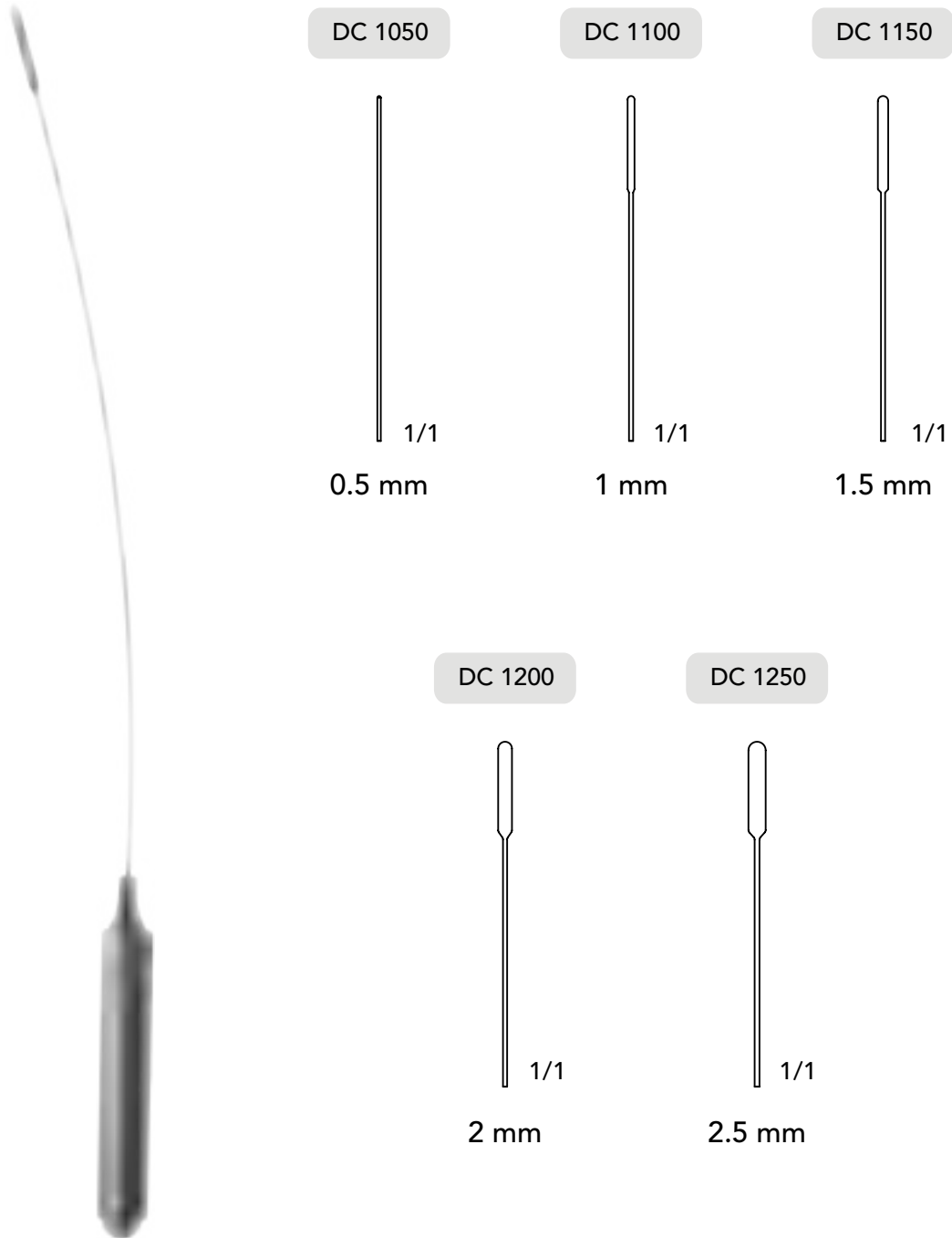

Coronary Silver Probes 7" (180 mm)

DD 4120

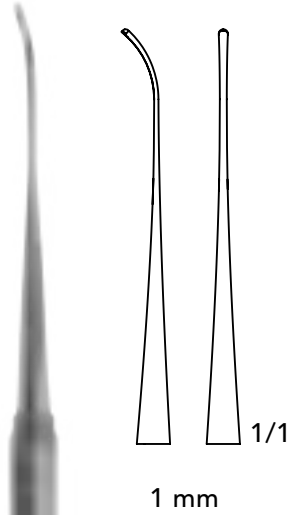

DD 4220

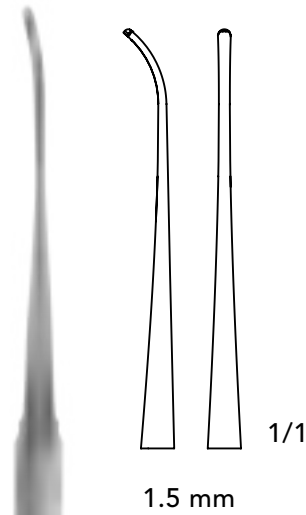

DD 4320

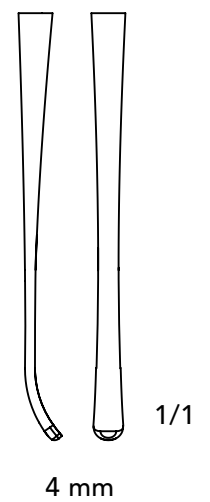
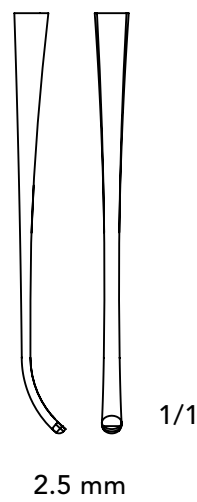
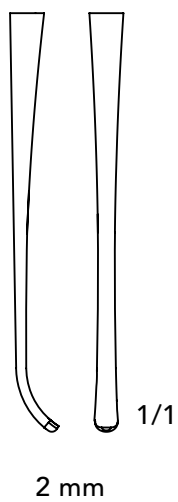
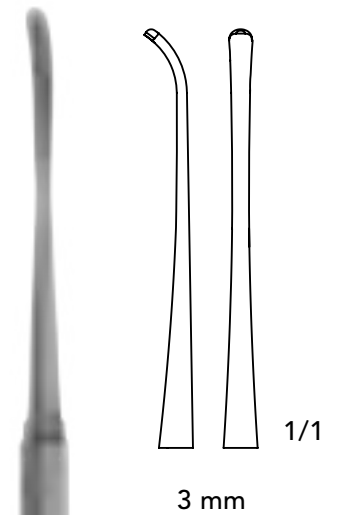

Coronary Dessectors Double End 8" (200 mm)







## Ring Handle Bulldog Clamps



VC 54013

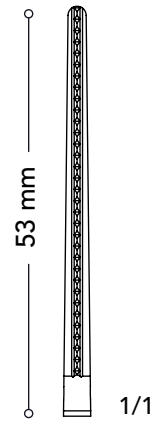

5 1/8" (130 mm)

VC 54113

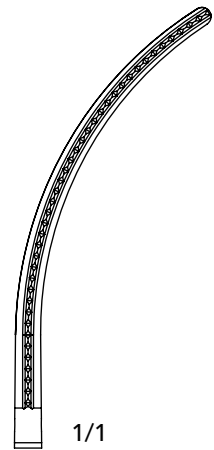

5" (125 mm)

VC 54410

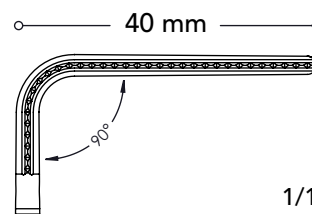

4 1/8" (100 mm)

### DeBakey Ring Handle Bulldog Clamps

## Ring Handle Bulldog Clamps

VC 54212



1/1

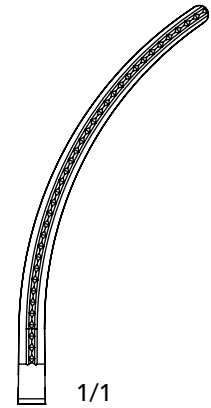

1/1

5" (125 mm)  
S - Shape Curved

VC 54313

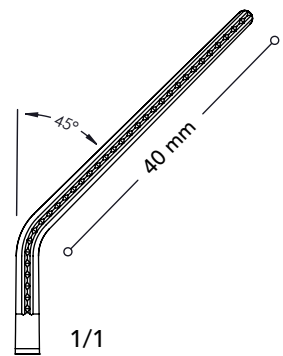

1/1

5" (125 mm)  
S - Shape Angled

### DeBakey Ring Handle Bulldog Clamps

## Neonatal Castaneda clamps

VC 58112

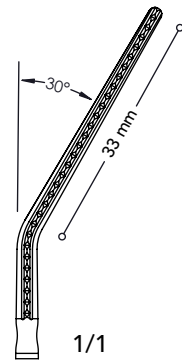

4 3/4" (120 mm)

VC 58212

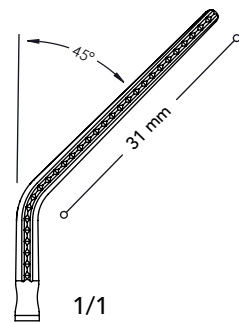

4 3/4" (120 mm)

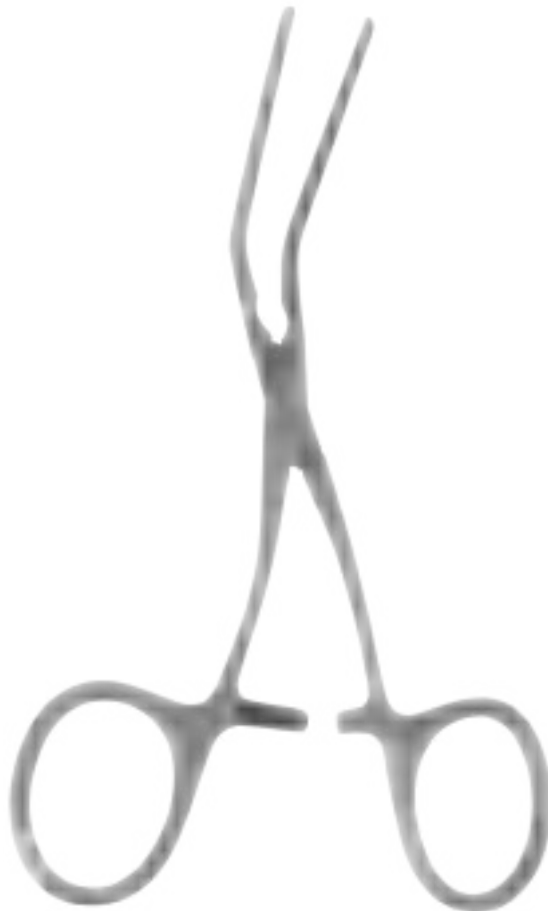

### DeBakey Neonatal Castaneda Angled Clamps

## Neonatal Castaneda Clamps



VC 59015

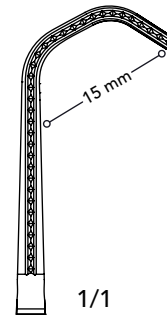

6" (150 mm)

VC 59115

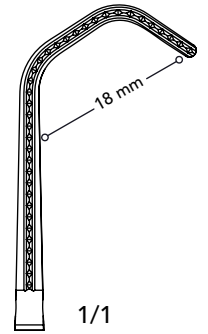

6" (150 mm)

VC 59215

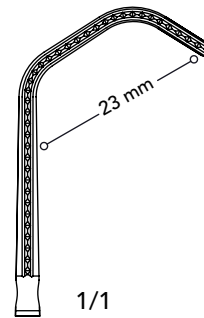

6" (150 mm)

VC 59315

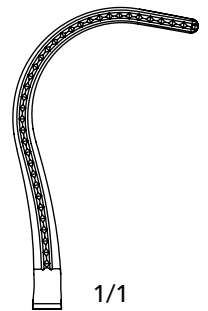

6" (150 mm)

### DeBakey Neonatal Castaneda Curved Clamps



VC 55716

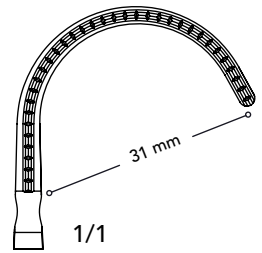

6 1/2" (165 mm)

VC 55816

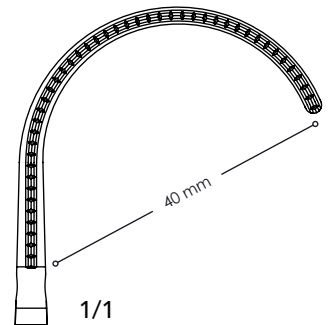

6 1/2" (165 mm)

Debakey Multi Purpose Clamps Deep Curved

## Angled Multi Purpose Clamps

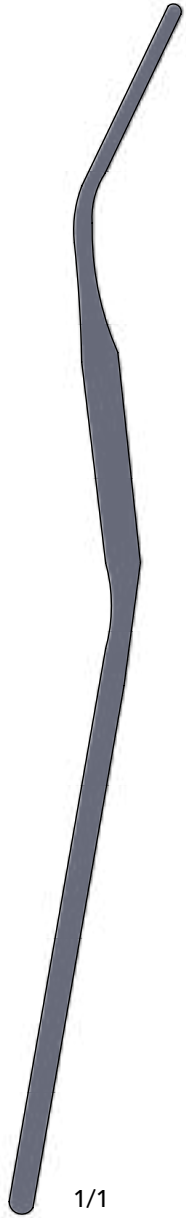

VC 56716

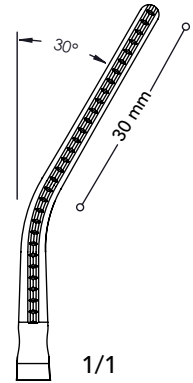

6 1/2" (160 mm)

VC 56816

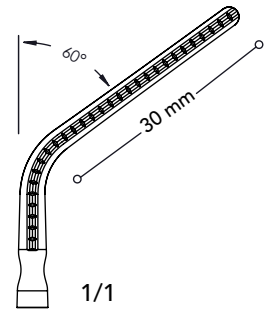

6 1/2" (160 mm)

VC 56915

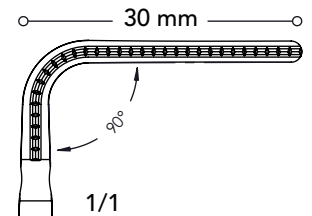

6" (150 mm)

Debakey Multi Purpose Clamps Angled

## Derra Cooley Clamps



VC 55917

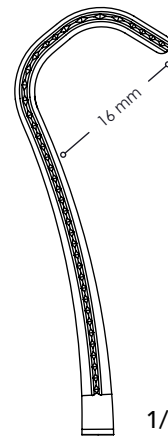

6 3/4" (170 mm)

VC 56017

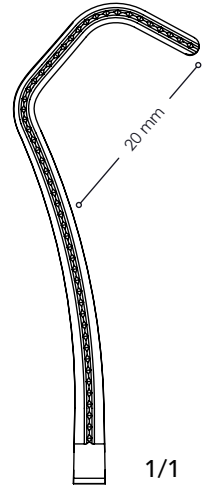

6 3/4" (170 mm)

VC 56118

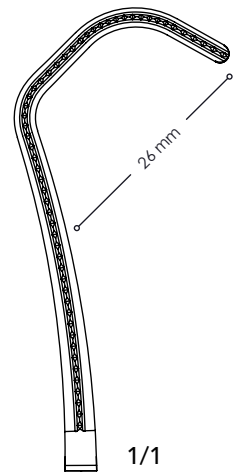

7" (180 mm)

Debakey Derra Cooley Clamps



## Derra Cooley Clamps



VC 56316

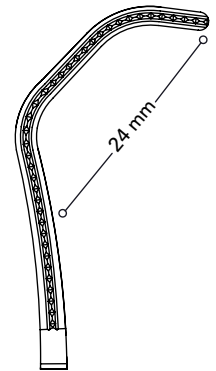

6 ¼" (160 mm)

Debakey Derra Cooley Clamps



## Ligature Clamps



VC 48419

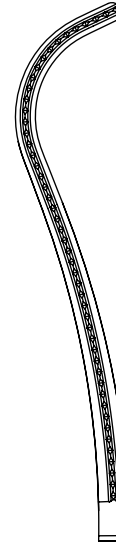

1/1

7 1/2" (190 mm)  
77 mm Jaw

VC 49821

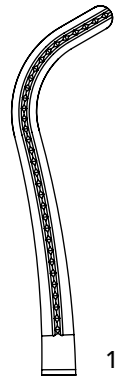

1/1

8 1/4" (210 mm)  
51 mm Jaw

VC 48523

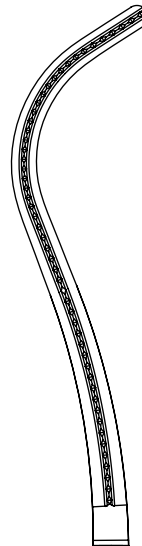

1/1

9" (230 mm)  
80 mm Jaw

VC 49923

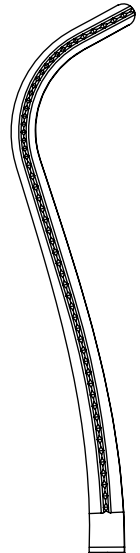

1/1

9" (230 mm)  
75 mm Jaw

Debakey Ligature Clamps

## Beck Clamps

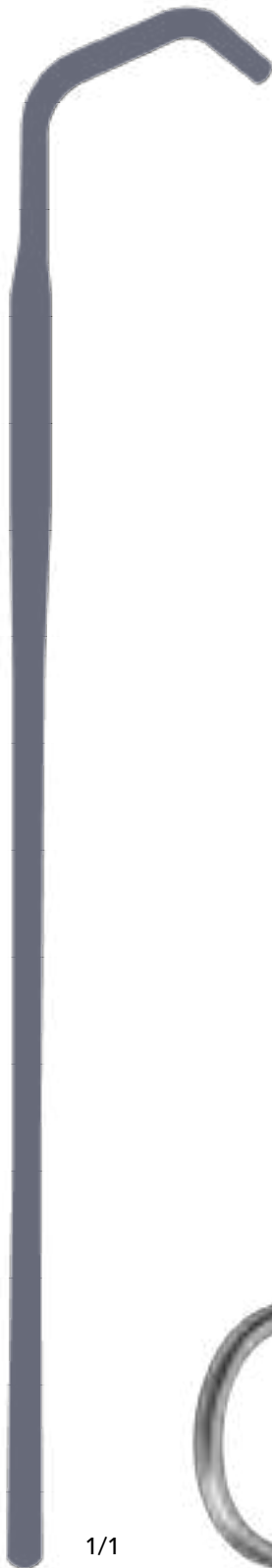

VC 51920

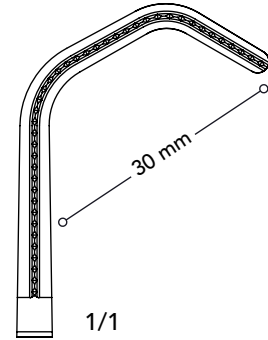

8" (200 mm)

VC 52021

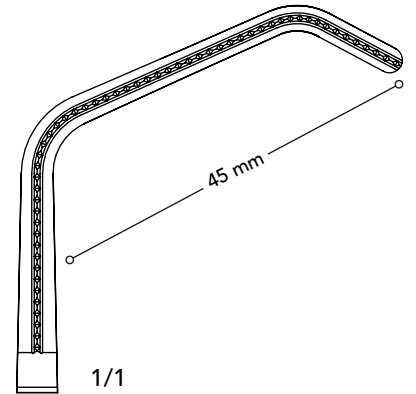

8 ¼" (210 mm)

Debakey Beck Clamps

## Herken Clamps



VC 52125

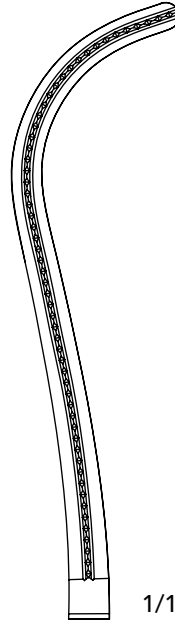

10" (255 mm)

VC 52225

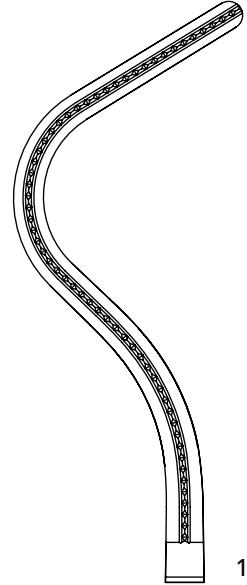

9 3/4" (250 mm)

VC 52325

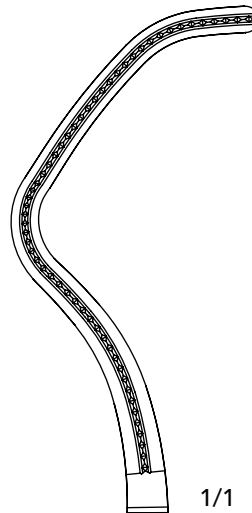

9 3/4" (250 mm)

VC 52425

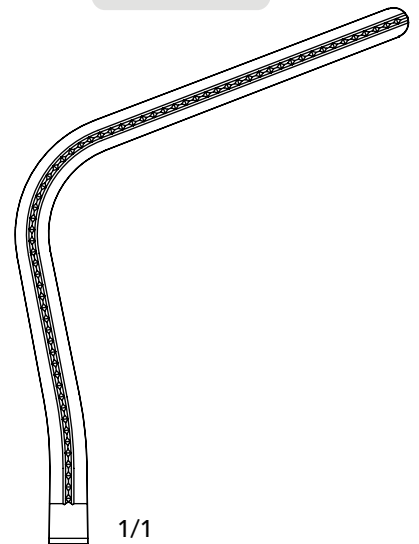

9 3/4" (250 mm)

### Debakey Herken Clamps

## Tangential Occlusion Clamps

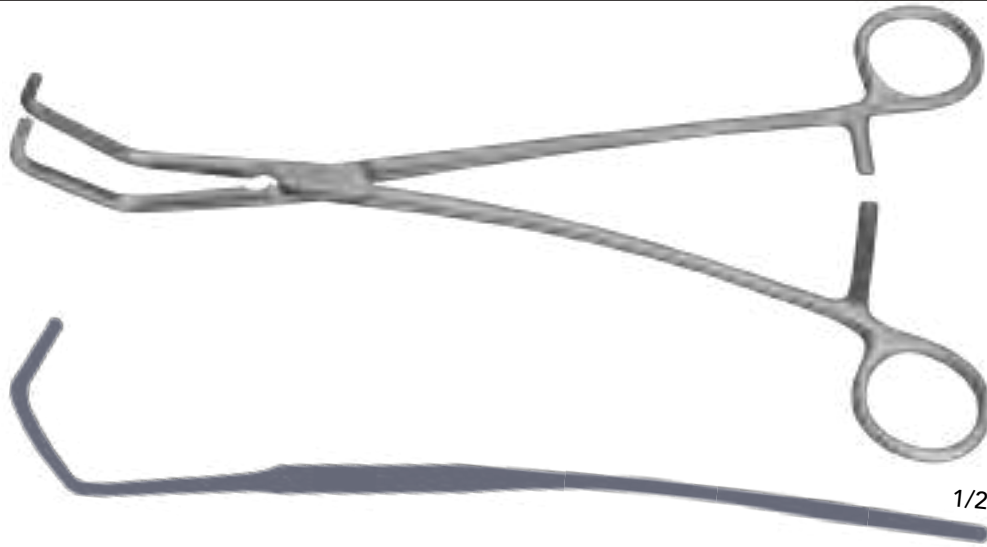

VC 50019

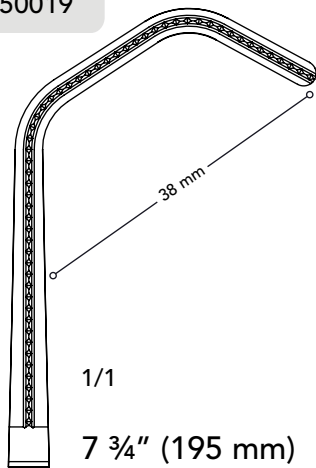

VC 50126

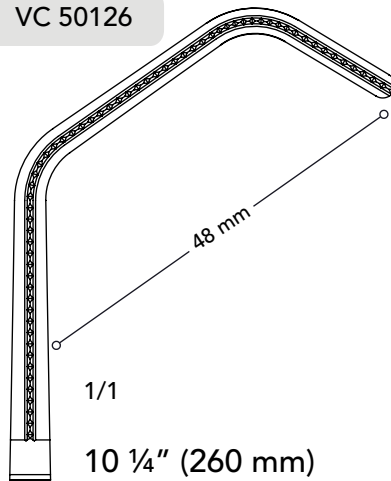

VC 50227

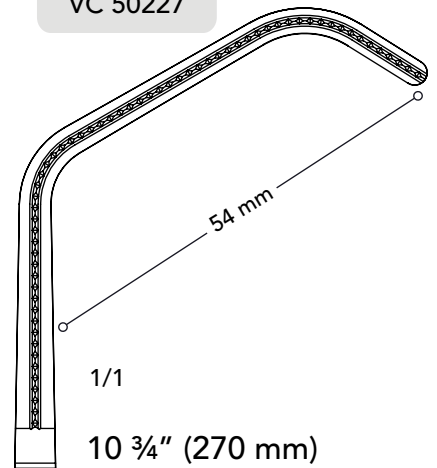

VC 50327

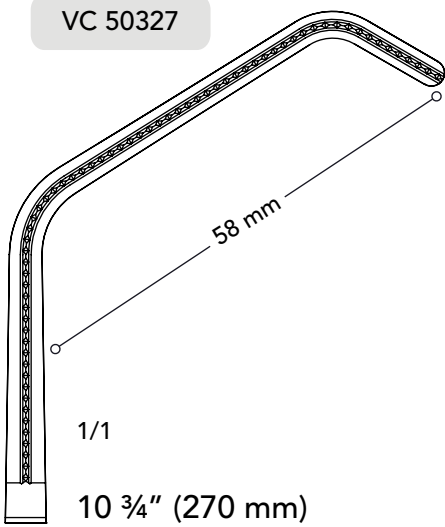

VC 50428

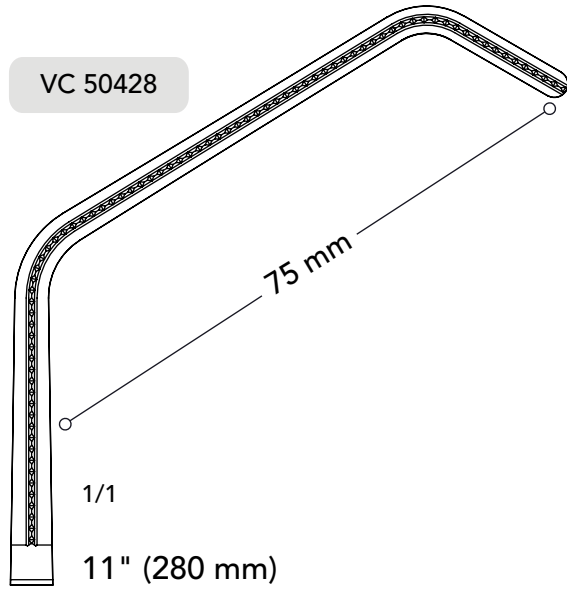

### DeBakey Tangential Occlusion Clamps

## Satinsky Clamps



VC 50624

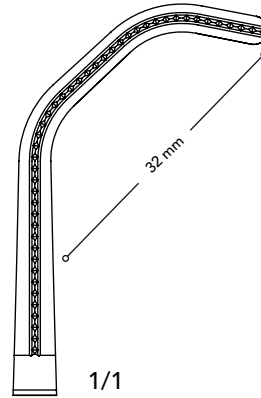

9 1/4" (235 mm)

VC 50724

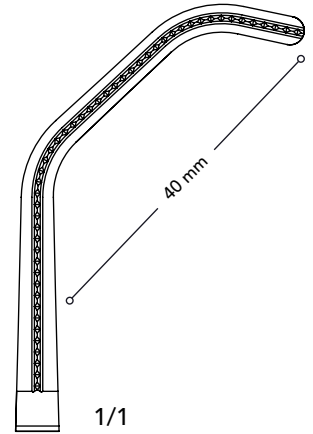

9 1/2" (240 mm)

VC 50824

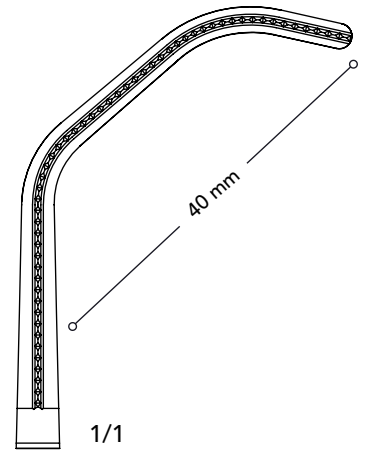

9 1/4" (235 mm)

Debakey Satinsky Clamps





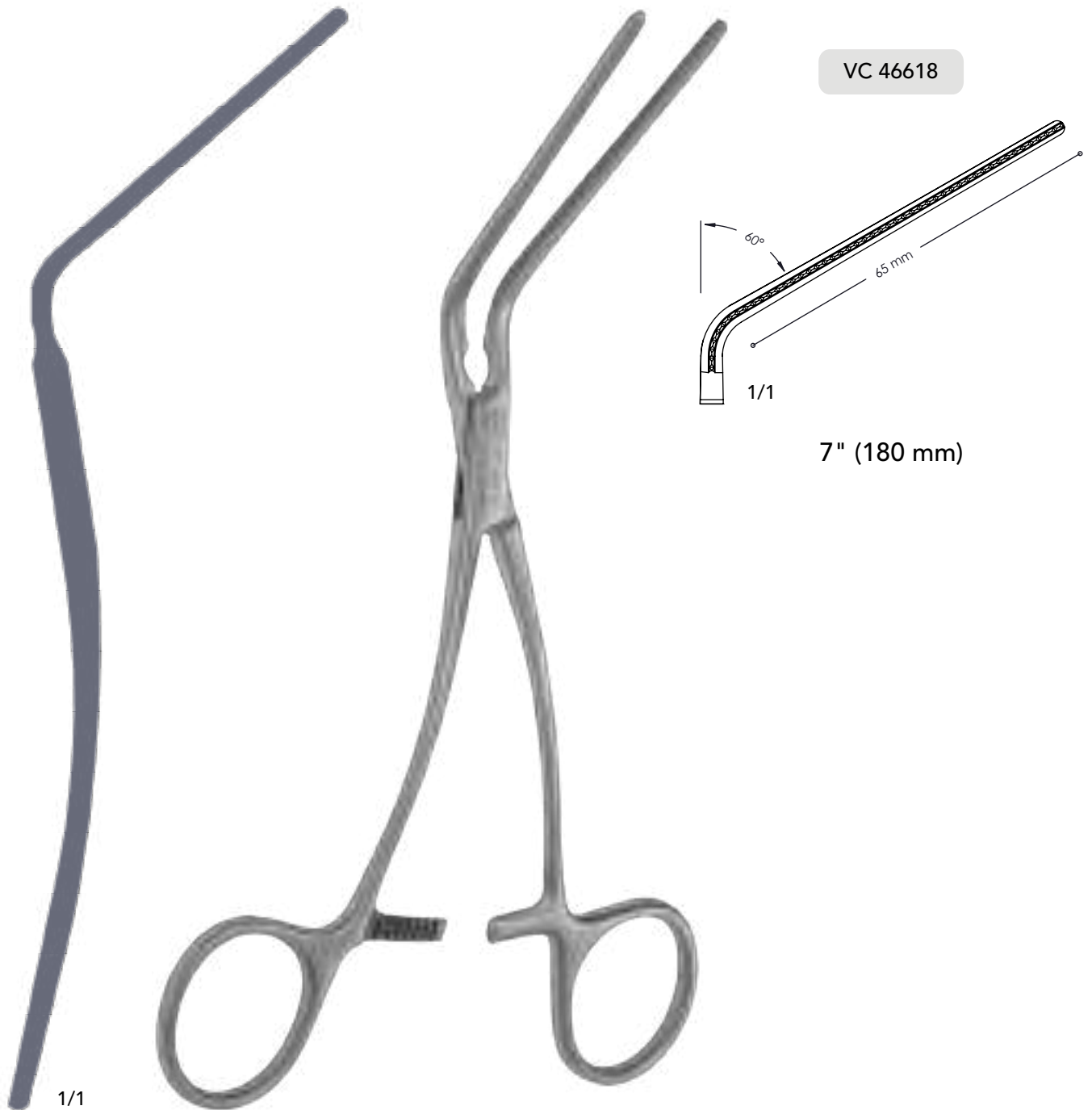

Debakey Cross Clamps

## Cross Clamps



1/1

VC 46919

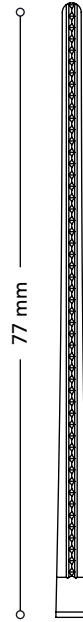

7 3/4" (195 mm)

1/1

VC 46819

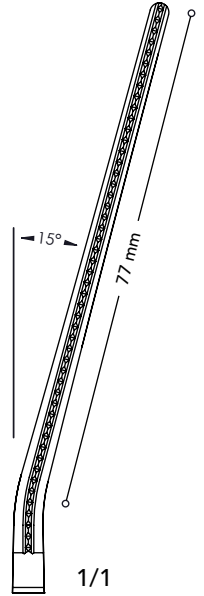

7 1/2" (190 mm)

1/1

VC 46719

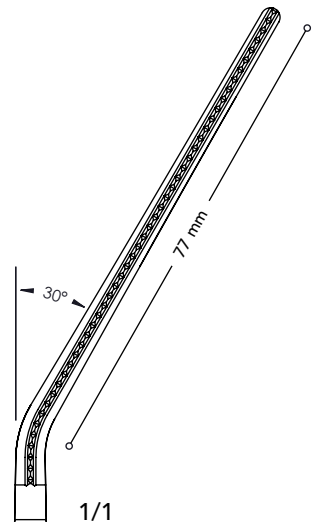

7 1/2" (190 mm)

1/1

Debakey Leland-Jones Cross Clamps

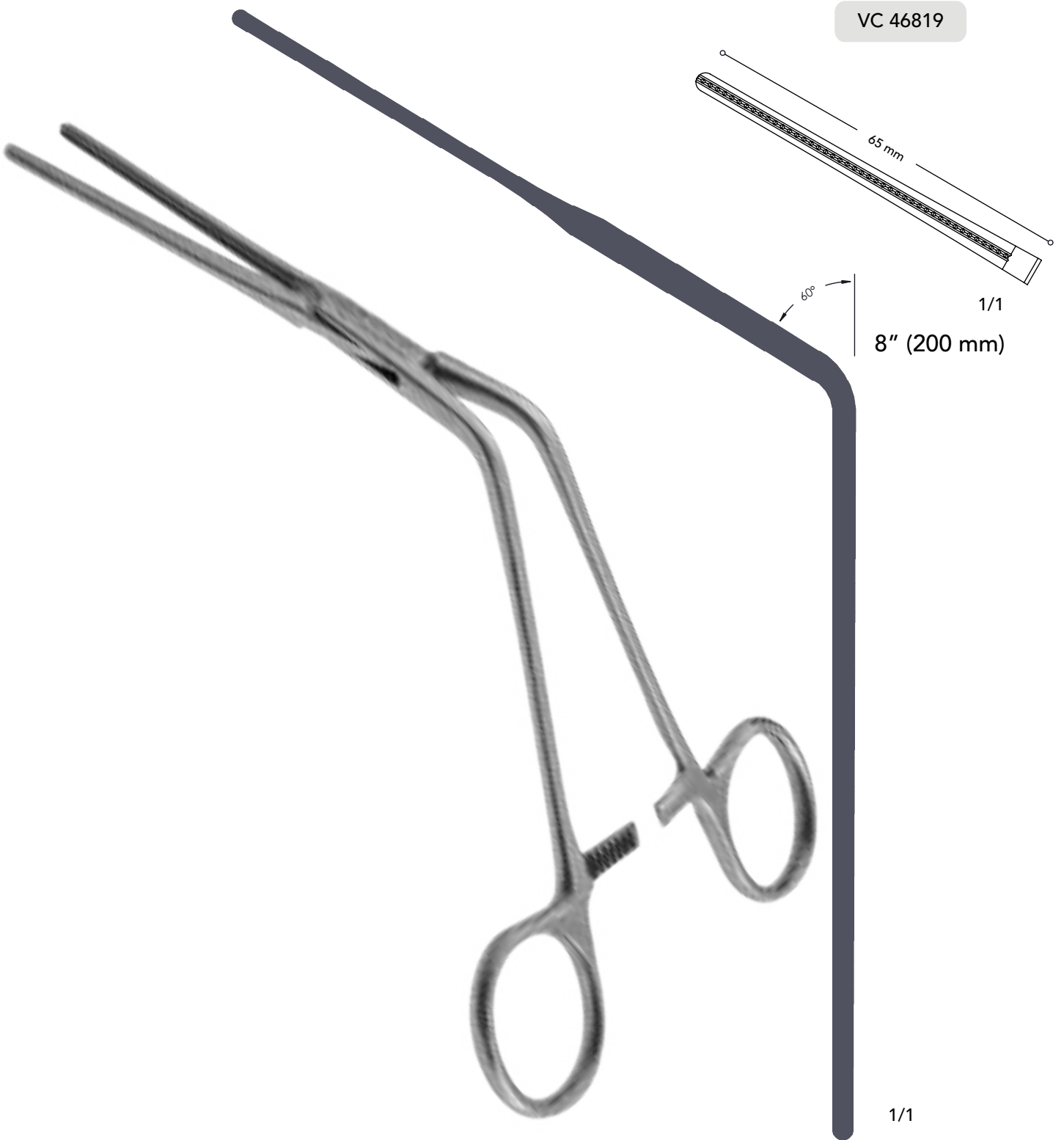

Debakey ILIACA Cross Clamp

## Cross Clamps

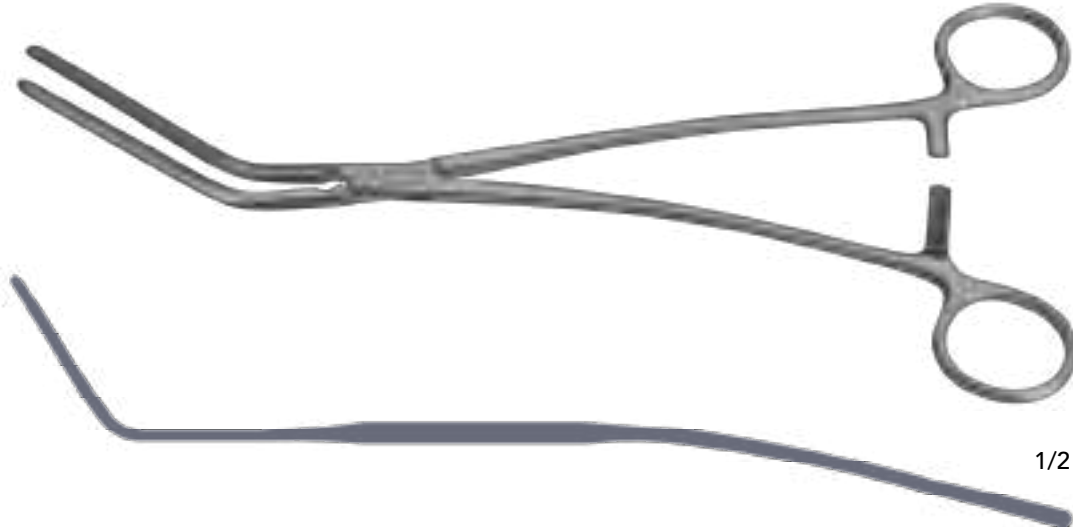

1/2

VC 51330

VC 51228

VC 51123

VC 51024

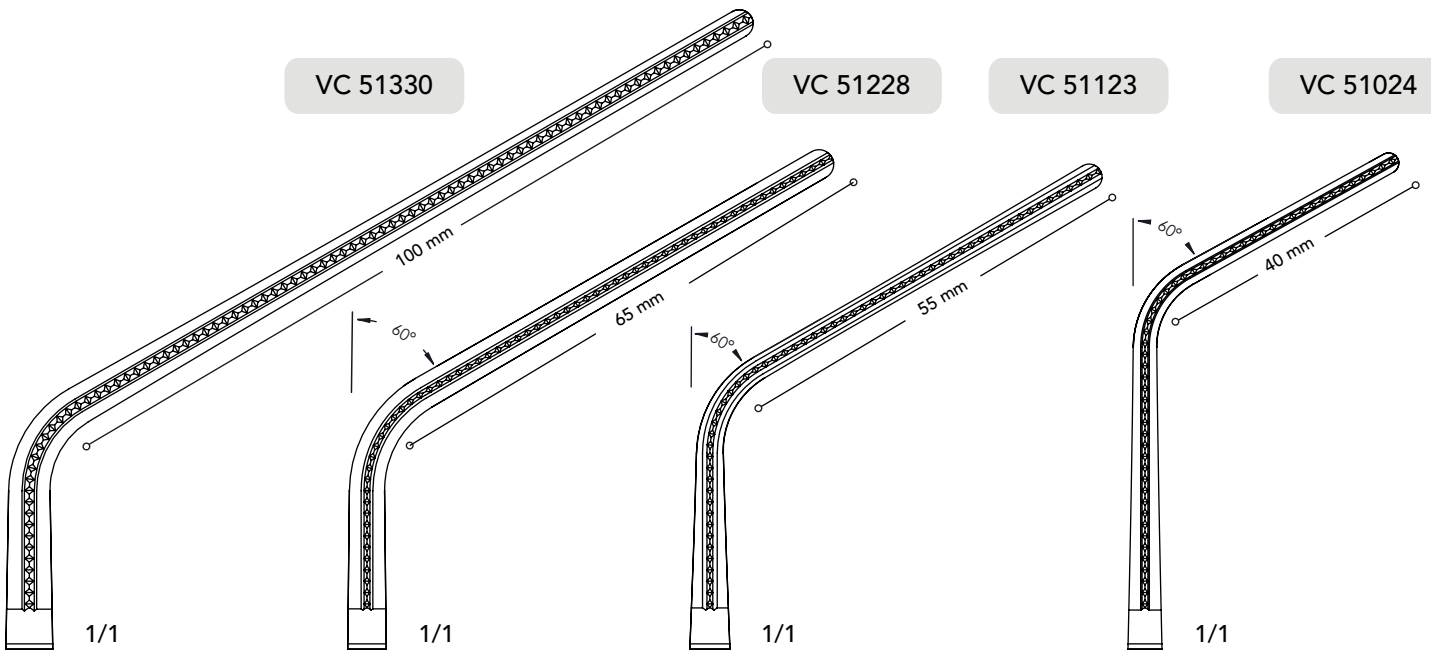

12" (300 mm)

11" (280 mm)

9" (230 mm)

9 1/2" (240 mm)

### Debakey Multi Purpose Angled Cross Clamps



## Cross Clamps

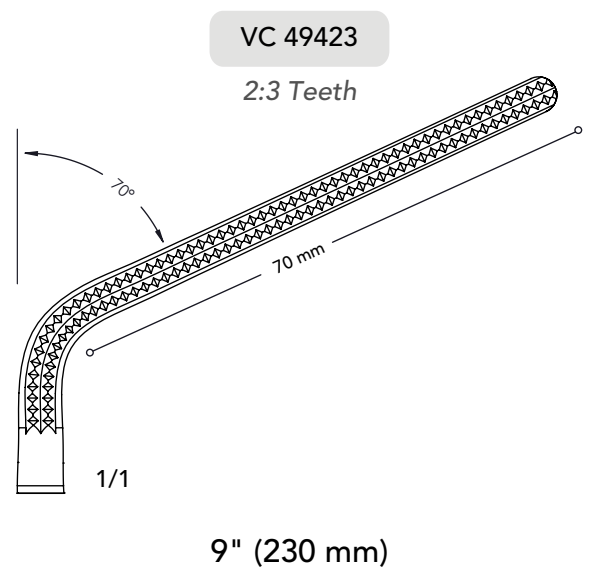
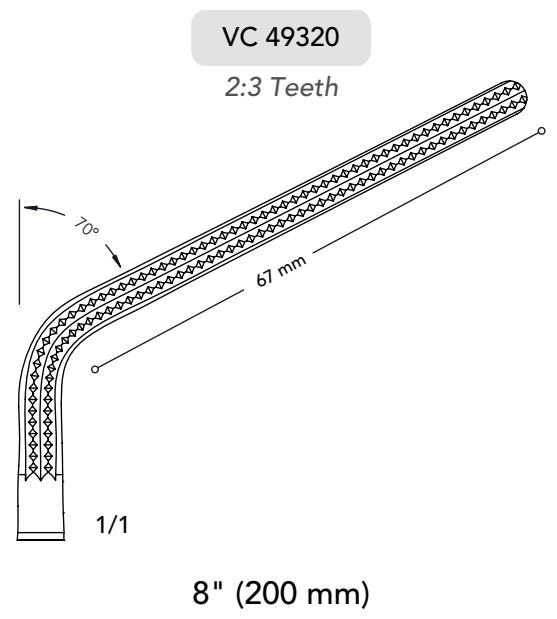

Debakey Cross Clamps  
(2:3 Teeth)

## SEMB Arota Aneurysm Clamps



3/4

VC 48127

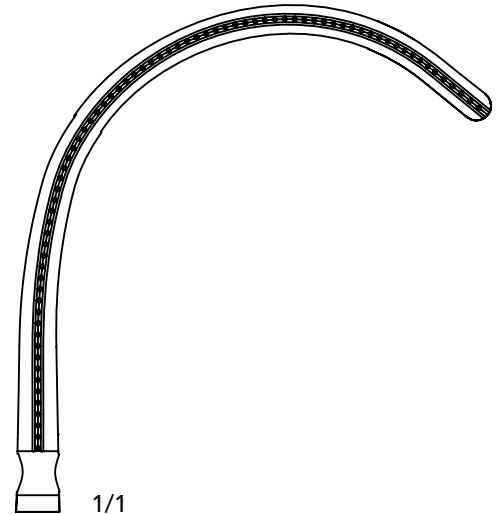

1/1

10 3/4" (270 mm)

VC 48225

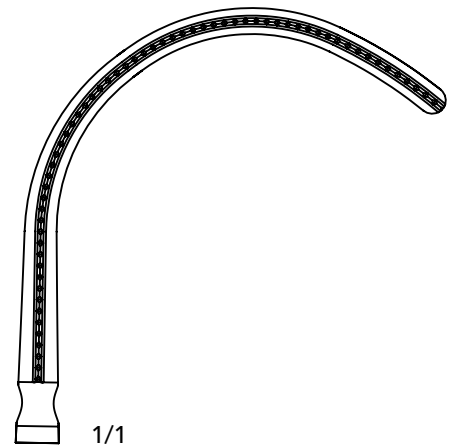

1/1

10 1/2" (265 mm)

Debakey SEMB Arota Aneurysm Clamps

## Aorta Aneurysm Clamps

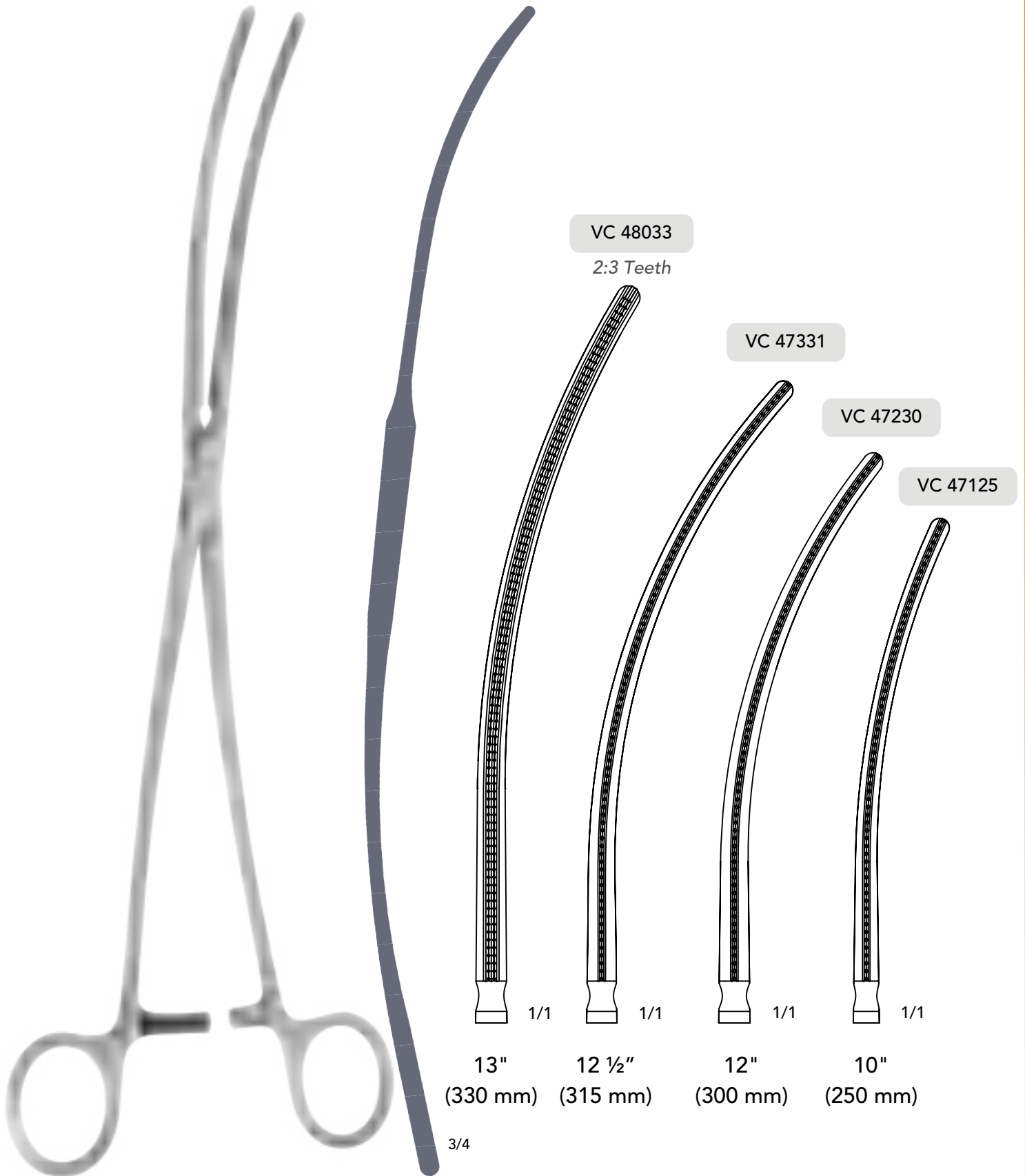

Debakey Aorta Aneurysm Clamps



## Arota Clamps



VC 49526

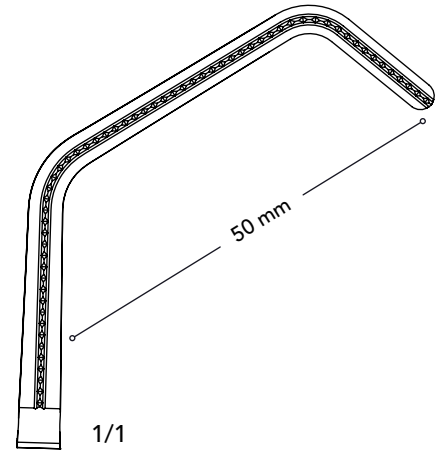

10 1/4" (260 mm)

VC 52521

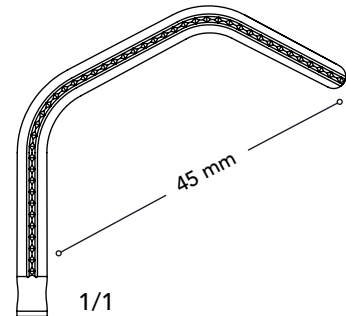

8 1/4" (210 mm)

Debakey Diethrich and Ochsner arota Clamps

## Lambert-Key Clamps



VC 49022

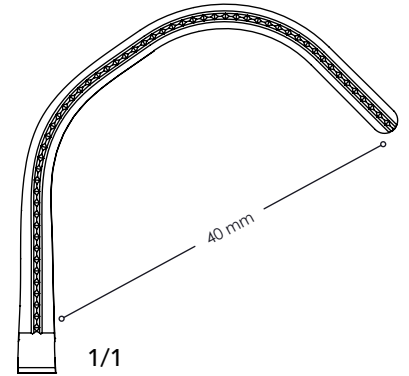

8 1/2" (215 mm)

VC 49126

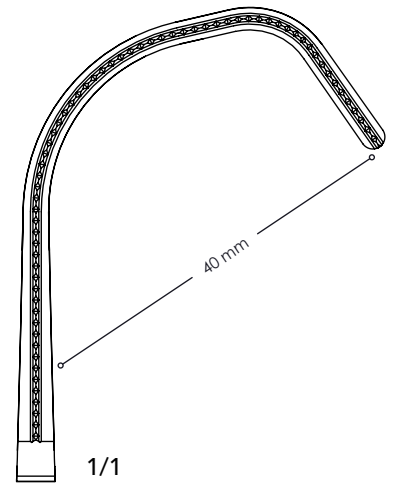

10" (255 mm)

VC 49221

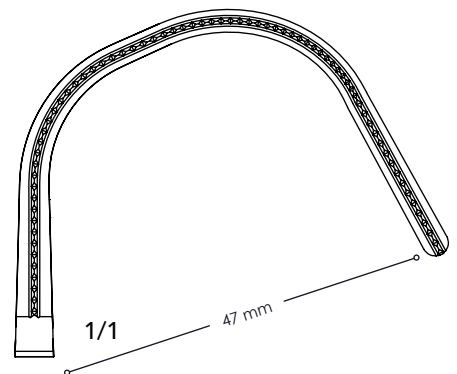

8 1/2" (215 mm)

### Debakey Lambert-Key Aorta Anastomosis Clamps

## Debakey Straight Clamp



VC 61012

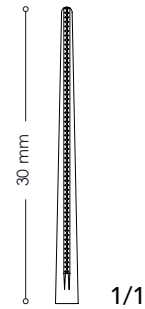

4 3/4" (120 mm)

Titanium Debakey Micro Clamp  
(Straight Shank)

## Debakey Side Biting Angled Clamps



VC 61611

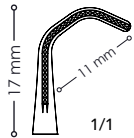

4" (100 mm)

VC 62012

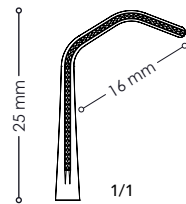

4 1/8" (105 mm)

VC 63612

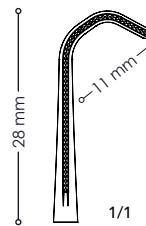

4 1/4" (110 mm)

VC 63712

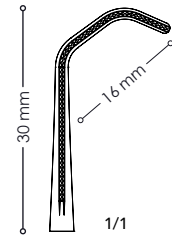

4 1/4" (110 mm)

Titanium Debakey Side Biting Micro Clamps  
(Angled Shanks)

## Debakey Angled Clamps



VC 61312

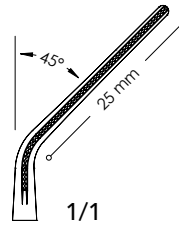

4 ¼" (110 mm)

VC 63312

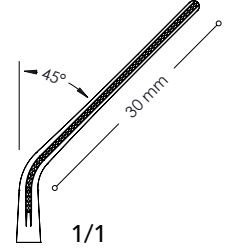

4 ½" (115 mm)

VC 61412

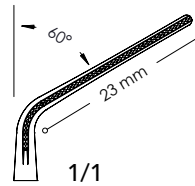

4 ⅛" (105 mm)

VC 63411

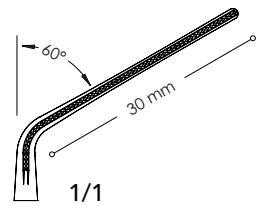

4 ¼" (110 mm)

VC 61512

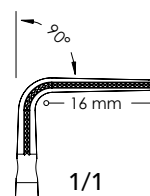

4" (100 mm)

VC 63512

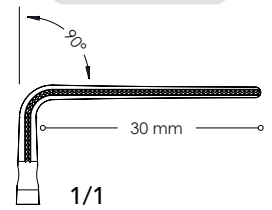

4" (100 mm)

Titanium Debakey Angled Micro Clamps  
(Straight Shanks)





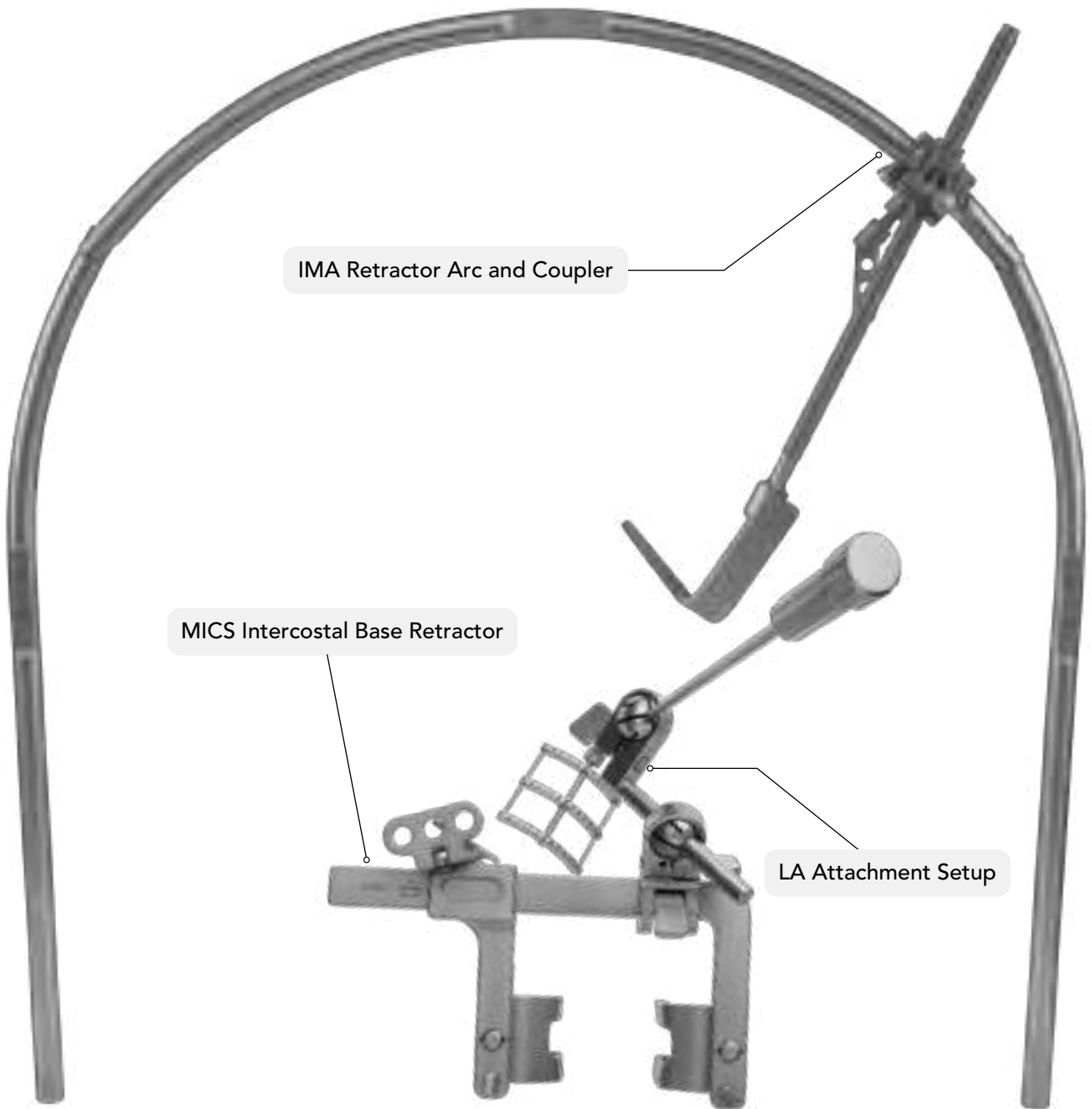



## MICS Intercostal Base Retractor

1001



MICS Intercostal Base Retractor

1002



35 x 40 mm Blade

1003



35 x 50 mm Blade

1004



35 x 60 mm Blade

## IMA Retractor Arc and Coupler

2001



Arc Top Part

2004



Coupler Set

2002



Arc Side Parts (Pair)

2005



70 x 70 mm - IMA Blade Small

2006



90 x 70 mm - IMA Blade Big

2003

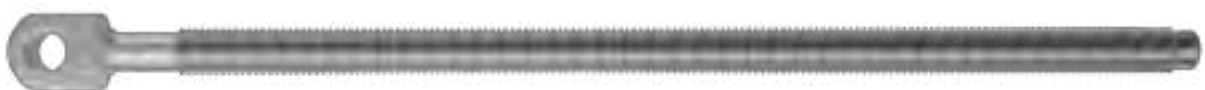

Puller Rod

5001



LA Ball Adapter

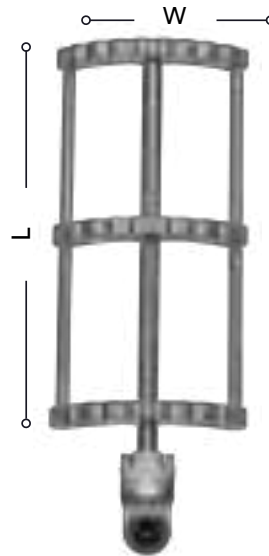

Code No	Size (L x W)
5101	45 x 30 mm
5102	60 x 30 mm
5103	45 x 45 mm
5104	60 x 45 mm

Atrial Blade

5002



LA Ball Adapter extender

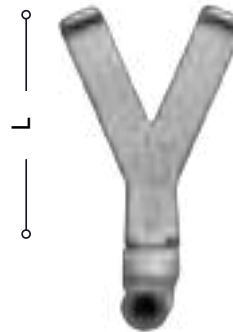

Code No	Size (L)
5201	30 mm
5202	40 mm
5203	50 mm
5204	60 mm
5205	70 mm

Atrial Hook

5003



LA Blade Lifter

5004



LA Blade Guiding Clamp



## **SRI DHANALAKSHMI INDUSTRIES**

Plot No .17, Masilamani Street, Siva Vishnu  
Nagar, Kundrathur, Chennai - 600069.

Email : [info@dhanamsurgical.com](mailto:info@dhanamsurgical.com)

 **+91 99401 10238**

